

Fatto a mano

Fatto a mano



AZIENDA CERTIFICATA
MUN
Società Cooperativa
N. TECOMUN-A000016



NIERI 

NIERI
dal 1929

NIERI

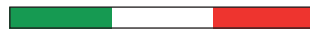

dal 1929

2016

NIERI is a trademark of ROMA IMPERIALE srl

Via Bologna, 13 - 51039 - Quarrata - PT- ITALY
tel: 0039 0573 7733 - fax: 0039 0573 739710

info@romaimperiale.net

www.romaimperiale.net www.nieri.it www.niericountry.it
www.nierifrance.com www.nieridivani.it

NIERI

MADE IN ITALY



ENGLISH

ITALIANO

DEUTSCH

FRANCAIS

ESPAÑOL

LEGENDA

ARMCHAIR	POLTRONA	SESSEL	FAUTEUIL	BUTACA
2 SEATER	2 POSTI	2 SITZER	2 PLACES	2 PLAZAS
2,5 SEATER	2,5 POSTI	2,5 SITZER	2,5 PLACES	2,5 PLAZAS
2 SEATER RELAX RIGHT/LEFT	2 POSTI RELAX DESTRA/SINISTRA	2 SITZER MIT OTTOMANE RECHTS/LINKS	2 PLACES RELAX DROITE/GAUCHE	2 PLAZAS RELAX DERECHO/IZQUIERDO
3 SEATER	3POSTI	3 SITZER	3 PLACES	3 PLAZAS
3 SEATER WITH MECHANISM	3 POSTI MECC	3 SITZER MIT FUNKTION	3 PLACES MECC	3 PLAZAS MECANISMO
3 SEATER WITH ORTHOPEDIC BED	3 POSTI LETTO ORTOPEDICO	3 SITZER MIT LATTENROSENBETT	3 PLACES LETTO ORTOPEDICO	3 PLAZAS CON CAMA ORTOPEDICO
3 SEATER MAX	3 POSTI MAX	3 SITZER MAX	3 PLACES MAX	3 PLAZAS MAX
3 SEATER MAX WITH CHAISE LONGUE RIGHT/LEFT	3 POSTI MAX RELAX DESTRA/SINISTRA	3 SITZER MAX OTTOMANE RECHTS/LINKS	3 PLACES MAX RELAX DROITE/GAUCHE	3 PLAZAS MAX RELAX DERECHO/IZQUIERDO
3 SEATER MAX WITH MECHANISM	3 POSTI MAX MECC	3 SITZER MAX MIT FUNKTION	3 PLACES MAX MECHANIQUE	3 PLAZAS MAX MECHANIQUE
CENTRAL ELEMENT	ELEMENTO CENTRALE	ZWISCHENELEMENT	ELEMENT CENTRAL	ELEMENTO CENTRAL
CENTRAL ELEMENT 2 SEATER	CENTRALE 2 POSTI	ZWISCHENELEMENT 2 SITZER	ELEMENT CENTRAL 2 PLACES	ELEMENTO CENTRAL 2 PLAZAS
END ELEMENT RIGHT/LEFT	TERMINALE DESTRA/SINISTRA	ENDELEMENT RECHTS/LINKS	TERMINAL DROITE/GAUCHE	TERMINAL DERECHO/IZQUIERDO
END ELEMENT 2 SEATER RIGHT/LEFT	TERMINALE 2 POSTI DESTRA/SINISTRA	ENDELEMENT 2 SITZER RECHTS/LINKS	TERMINAL 2 PLACES DROITE/GAUCHE	TERMINAL 2 PLAZAS DERECHO/IZQUIERDO
END ELEMENT 2 SEATER RELAX RIGHT/LEFT	TERMINALE 2 POSTI RELAX DESTRA/SINISTRA	ENDELEMENT 2 SITZER OTTOMANE RECHTS/LINKS	TERMINAL 2 PLACES RELAX DROITE/GAUCHE	TERMINAL 2 PLAZAS RELAX DERECHO/IZQUIERDO
END ELEMENT 2 SEATER MOVABLE BACK	TERMINALE 2 POSTI SPALLIERA MECCANICA	ENDELEMENT 2 SITZER SPALLIERA MECCANICA	TERMINAL 2 PLACES DOSSIER AMOVIBLE	TERMINAL 2 PLAZAS CON MECANISMO
END ELEMENT 2 SEATER MOVABLE ARMREST	TERMINALE 2 POSTI BRACCIOLO MOVIBILE	ENDELEMENT 2 SITZER BRACCIOLO MOVIBILE	TERMINAL 2 PLACES ACCOUDOIR MOVIBILE	TERMINAL 2 PLAZAS APOYABRATOS MOVIBILE
END ELEMENT 2 SEATER WITH ORTHOPEDIC BED	TERMINALE 2 POSTI LETTO DESTRA/SINISTRA	ENDELEMENT 2 SITZER LETTO RECHTS/LINKS	TERMINAL 2 PLACES LIT DROITE/GAUCHE	TERMINAL 2 PLAZAS CAMA DERECHO/IZQUIERDO
END ELEMENT RIGHT/LEFT SPEC. 45DEGR.	TERMINALE DX/SX 45°	ENDELEMENT RECHTS/LINKS 45°	TERMINAL DROITE/GAUCHE 45°	TERMINAL DROITE/GAUCHE 45°
END ELEMENT 3 SEATER RIGHT/LEFT	TERMINALE 3 POSTI DESTRA/SINISTRA	ENDELEMENT 3 SITZER RECHTS/LINKS	TERMINAL 3 PLACES DROITE/GAUCHE	TERMINAL 3 PLAZAS DERECHO/IZQUIERDO
END ELEMENT 3 SEATER RIGHT/LEFT WITH ORTHOPEDIC BED	TERMINALE 3 POSTI DESTRA/SINISTRA	ENDELEMENT 3 SITZER RECHTS/LINKS MIT LATTENROSENBETT	TERMINAL 3 PLACES DROITE/GAUCHE LIT	TERMINAL 3 PLAZAS DERECHO/IZQUIERDO CAMA
CHAISE LONGUE RIGHT/LEFT	CHAISE LONGUE DESTRA/SINISTRA	REKAMIERE RECHTS/LINKS	CHAISE LONGUE DROITE/GAUCHE	CHAISE LONGUE DERECHO/IZQUIERDO
CHAISE LONGUE RIGHT/LEFT WITH HEADREST	CHAISE LONGUE DESTRA/SINISTRA POGGIATESTA	REKAMIERE RECHTS/LINKS KOPFSTUETZE	CHAISE LONGUE DROITE/GAUCHE APPUIS TETE	CHAISE LONGUE DERECHO/IZQUIERDO APOYACABEZA CHAISE
CHAISE LONGUE SQUARED RIGHT/LEFT	CHAISE LONGUE SQUADRATA DESTRA/SINISTRA	REKAMIERE CARIERT RECHTS/LINKS	CHAISE LONGUE CARRÉ DROITE/GAUCHE	LONGUE CONTENEDOR DERECHO/IZQUIERDO
PENINSULA RIGHT/LEFT	PENISOLA DESTRA/SINISTRA	PENINSEL RECHTS/LINKS	ILE DROITE/GAUCHE	PENINSULA DROITE/GAUCHE
CORNER	ANGOLO	ECKE	ANGLE	RINCON
SOUND CORNER	ANGOLO SOUND	ECKE SOUND	ANGLE SOUND	RINCON SOUND
CENTRAL SOUND STORAGE	CONTENTITORE CENTRALE SOUND	ZWISCHENELEMENT SOUND MIT BEHAELTER	COFFRE ELEMENT CENTRAL SOUND	CONTENEDOR ELEMENTO CENTRAL SOUND
CORNER/TABLE	TAVOLO CORNER	TISCH/ECKE	ANGLE/TABLE	RINCON/MESA
CORNER NAPOLEON	ANGOLO NAPOLEON	NAPOLEON ECKE	ANGLE NAPOLEON	RINCON NAPOLEON
ROUND CORNER	ANGOLO ROUND	RUNDE ECKE	ANGLE ROUND	RINCON ROUND
MANUAL RECLINER	POLTRONA MECC MANUALE	TV SESSEL MANUELLE	FAUTEIL RECLINER MANUELLE	BUTACA RELAX CON FUNCION MANUAL
SOFABED	DIVANO LETTO	SOFABETT	RAPIDO	SOFACAMA
ORTHOPEDIC BED	LETTO ORTOPEDICO	LATTENROSENBETT	LIT	CAMA
ROLL CHAIR	POLTRONA ROLL	ROLL SESSEL	FAUTEIL PIVOTANT	BUTACA CON GIRATORIO
ROLL CHAIR WITH MECHANISM	POLTRONA ROLL MECCANISMO	ROLL SESSEL MIT FUNKTION	FAUTEIL ROLL MECANIQUE	BUTACA CON GIRATORIO Y MECANISMO
ROUND SEAT XXL	ROUND SEAT XXL	ROUND SEAT XXL	ROUND SEAT XXL	ROUND SEAT XXL
FOOTSTOOL	POUF	HOCKER	POUF	POUF
FOOTSTOOL RIGHT /LEFT	POUF DESTRA/SINISTRA	HOCKER RECHTS/LINKS	POUF DROITE/GAUCHE	POUF DERECHO/IZQUIERDO
FOOTSTOOL MAX	POUF MAX	HOCKER MAX	POUF MAX	POUF MAX
DROP SHAPED FOOTSTOOL	POUF GOCCIA	HOCKER GOCCIA	POUF GOCCIA	POUF GOCCIA
CASE/ FOOTSTOOL	POUF CONTENITORE	HOCKER MIT BEHAELTER	POUF COFFRE	POUF CONTENEDOR
BACK CUSHIONS	CUSCINO SPALLIERA	RUECKEN KISSEN	COUSSIN DE DOSSIER	COJIN DE RESPALDO
HELP LUMBAR CUSHION	CUSCINO POGGIARENI	NIEREN KISSEN	COUSSIN CALEREIN	COJIN HELP
PILLOW 45X45	CUSCINO 45X45	KISSEN 45X45	COUSSIN 45X45	COJIN 45X45
HEADREST	POGGIATESTA	KOPFSTUETZE	APPUYE TETE	APOYACABEZA
RECTANGULAR TABLE	TAVOLO RETTANGOLARE	TISCH RECHTECKIG	TABLE RECTANGULAIRE	MESA RECTANGULAR
ROUND TABLE	TAVOLO TONDO	RUND TISCH	TABLE RONDE	TABLE REDONDA
OVAL TABLE	TAVOLO OVALE	OVAL TISCH	TABLE OVAL	TABLE OVAL
SIDE TABLE	TAVOLO LATERALE	BEISTELL TISCH	TABLE LATERAL	TABLE LATERAL

*MODERN COLLECTION

- 12 _Alison
- 16 _Arizona
- 20 _Bauli
- 24 _Beverly
- 30 _Brooklyn
- 34 _California
- 38 _Cassandra
- 42 _Cinemax
- 44 _Compass
- 46 _Cristina k
- 48 _Dakota
- 52 _Dallas
- 54 _Delia
- 58 _Dominique
- 60 _Espace & _Norma
- 66 _Galaxy
- 68 _Kespace
- 70 _Kosmos
- 74 _Lipari
- 76 _Louis
- 78 _Madison
- 82 _Manchester
- 86 _Marathon
- 90 _Matisse e _Matisse L.

- 96 _Maud
- 98 _Memphis
- 100 _Metropolitan
- 104 _Mexico
- 106 _Miami
- 108 _Morena
- 110 _Nathalie & _Nathalie K
- 112 _Park Avenue
- 114 _Ratina
- 118 _Sidney
- 120 _Studio e _Maldiva
- 122 _Versus
- 126 _Wes

ARM+CHAIRS

- 130 _Cristina
- 132 _Easy
- 133 _Gatsby
- 134 _Mida
- 136 _Mimosa
- 137 _Moira
- 138 _My Chair



COMPANY WITH MANAGEMENT SYSTEM
 ITCOT.MUN NATIONAL MANUFACTURING
 MARCHIO UNICO NAZIONALE

* FOR NIERI'S CLASSIC COLLECTION PLEASE ASK FOR THE CATALOGUE

INTRODUCTION

ABOUT US_ A BIT OF HISTORY

The headquarter of Roma Imperiale srl, the young company which distributes the long known brand Nieri, is in Quarrata in the heart of Tuscany: a land of art and beauty.

Born from the passion and creativity of Alberto Nieri, the third generation after the founder Gino, the brand Nieri is now a reality of global significance for the number of exports and for the undisputed quality of its lounges. The company is currently managed by the fourth generation of the Nieri's family, being as a matter of fact a Family Business since 1929. Rarely indeed the story of a company, is identified so closely with the story of a family such as for Nieri.

With the work of generations Nieri's Family has built, from nothing, a production which today has an international feel.

The production units are concentrated where the technical, administrative and commercial control unit is located, that is, all in Tuscany. All materials such as leather, fabric, wood and rubber come from Tuscany or the north of Italy.



Historical facts:

1929 the grandfather Gino, a young carpenter who is distinguished by excellent technical skills and for his original creations, began creating wooden structures for upholstered furniture.

Learned the art of making chairs and sofas, Gino started designing and manufacturing the pieces of furniture entirely on his own and managed to create exclusive furniture as for originality, quality and style.

In the 50s, his son, Mauro Nieri contributed to the expansion of the company with new energy and fresh ideas on the Italian market. In this way the tradition passed into the hands of the second generation.

In the 70ies Mauro was joined, already at an early age, by his son Alberto, who also participates in the company's development also on the international scene by taking part in the most important trade fairs and exhibitions Worldwide, therefore increasing the company's export level.

In recent years Alberto received the help of his brother Maurizio, his daughter Jessica and his cousin Susanna whose managerial professionalism is expressed in remarkable successes in new markets and new channels, carefully chosen and managed.

Today at the fourth generation, the company is still carried out by the Nieri Family which with new globalized projects and opened towards a younger audience is increasingly entering large and diverse market segments.

The design Nieri is a process that involves love of form, comfort, quality. Each approved design is the result of careful studies and long analysis.

The production cycle begins with the cutting and the stitching of leather and fabrics, all swatches carefully and strictly selected.



Together with flair for style and details but also attention to the production, Nieri uses a total quality system according to international standards and it's certified by MUN as National Manufacturer, a certificate that guarantees that the origin of all products is 100% Made in Italy. The MUN Registration number for Nieri is ITCOT.MUN-A0000016

Nieri is nowadays exporting in over 62 countries in the world its high quality sofas and armchairs, all made with the best design and the best Italian style.



Once processed, the wooden frames are elegantly handled by master painters and collected in the various production centers for the assembly. Meanwhile, upholsterers create stuffing pillows and backrests with a technology and an attention that can only be appreciated by sitting on an exclusive sofa Nieri.

Industrial production is combined with the craft technique so that the product obtained is unique and comparable to a true work of art. Upholsterers and assemblers create one by one the pieces of furniture combining leather, fabrics and rubber, taking care centimeter by centimeter of every detail, giving shape, beauty and harmony to the composition.

The result: a "unique piece" designed and studied in detail.

Even the packaging, distinguishes the company from the "other" for attention, protection and safety: a Nieri Sofa deserves every care!



MODERN COLLECTION





MODERN COLLECTION

_Alison



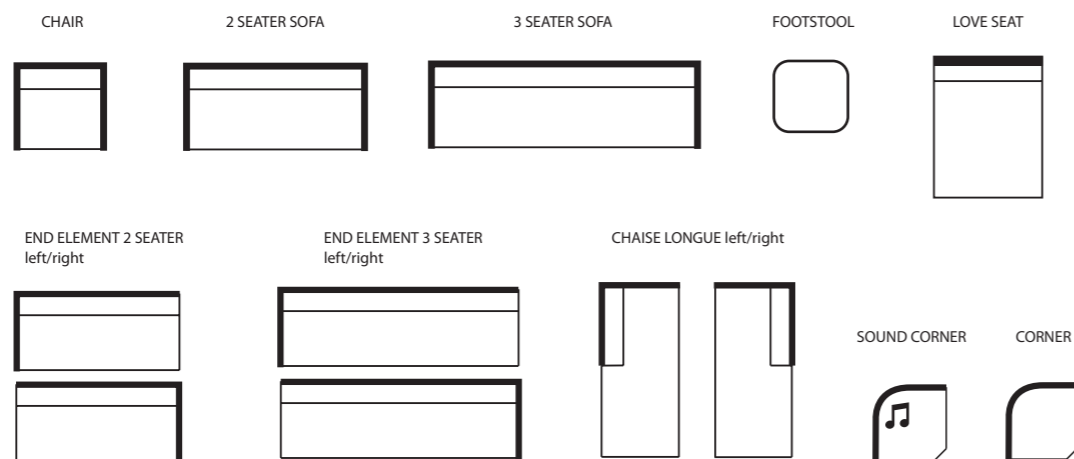

ELEMENTS

	H	L	D	V	W
ALISON ARMCHAIR	72	82	103	0,70	25
ALISON LOVE SEAT	70	121	174	1,50	52
ALISON SOFA 2 SEATER	70	200	104	1,50	60
ALISON END ELEMENT 2 SEATER	70	140	104	1,30	53
ALISON SOFA 3 SEATER	70	236	104	1,80	67
ALISON END ELEMENT 3 SEATER	70	184	104	1,50	57
ALISON CHAISE LONGUE	70	97	175	1,20	46
ALISON CORNER SOUND	63	115	115	1,10	58
ALISON CORNER	63	115	115	0,85	48
ALISON FOOTSTOOL	40	60	60	0,20	13
ALISON PILLOWS		70	50		

- * For this kind of sofa we recommend using only Extra quality leather and strong non patterned fabric.
- * Combined version leather/fabric is not available.
- * In case you order a Corner Element we recommend choosing also the corresponding back seat loose pillows 40x40 cm.
- * Different combination of coverings or different sizes are not previewed in our system. Special requests, if possible, will be considered a "not standard product" and a 10% surcharge will be applied.



MODERN
COLLECTION

_Arizona



_Arizona



ELEMENTS	H	L	D	V	W
ARIZONA SOFA 3 SEATER	74/94	225	105	1,75	80
ARIZONA SOFA 2 SEATER	74/94	185	105	1,45	70
ARIZONA ARMCHAIR	74/94	100	105	0,80	50

* Position of headrests is manually adjustable in different angles.
 * Different combination of coverings or different sizes are not previewed in our system. Special requests, if possible, will be considered a "not standard product" and a 10% surcharge will be applied.



MODERN COLLECTION

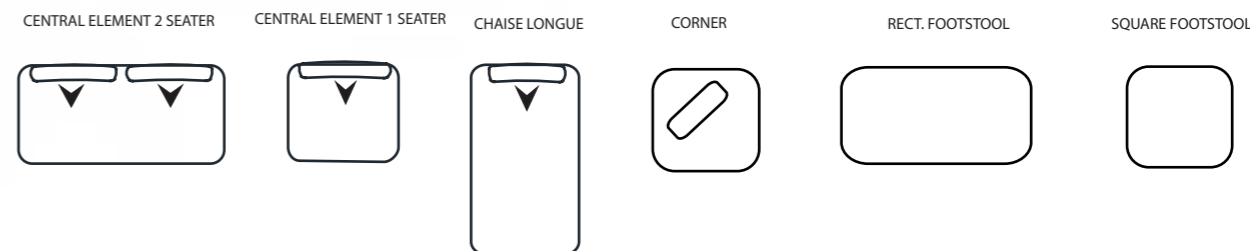
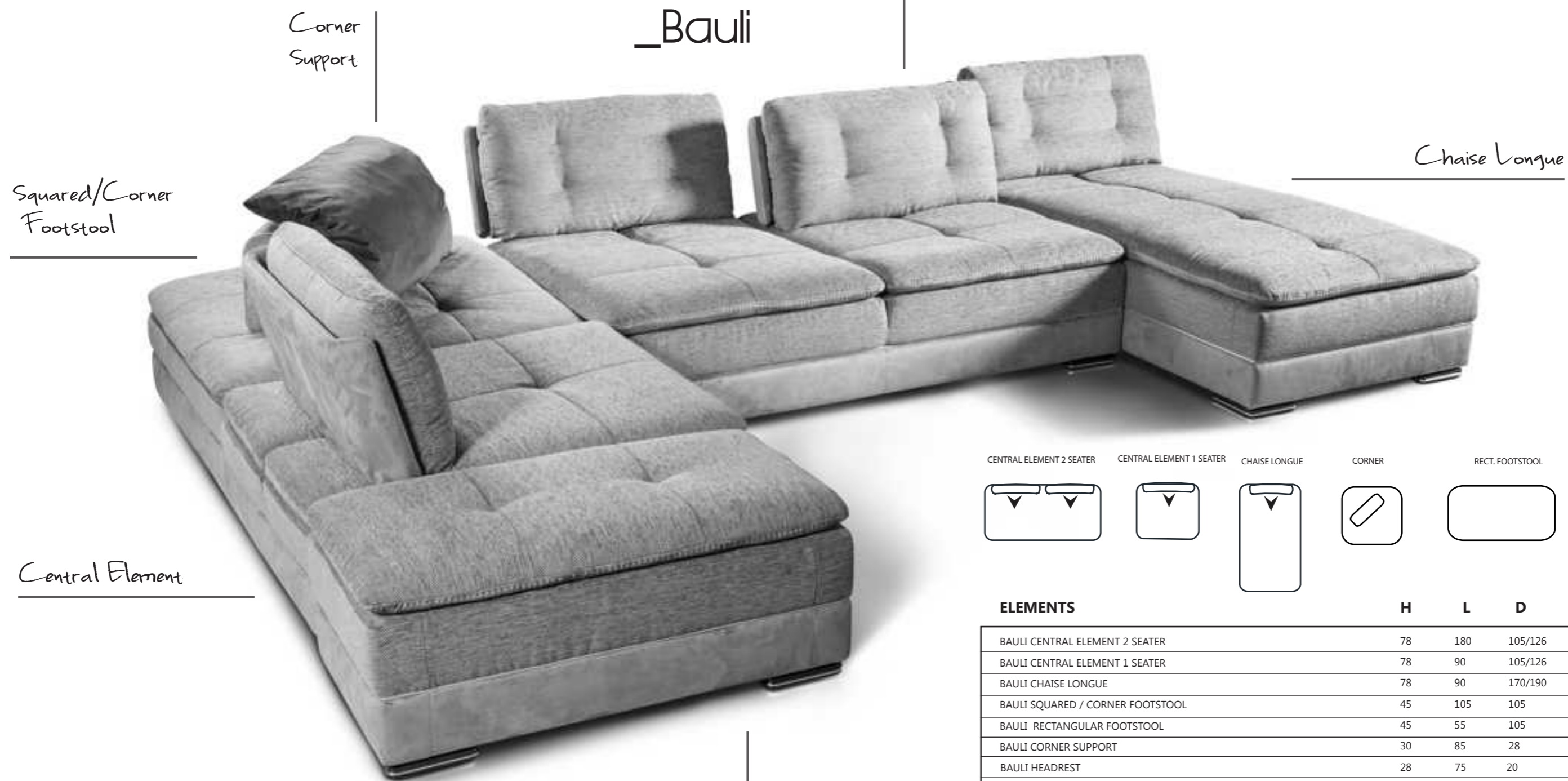

ELEMENTS	H	L	D	V	W
BAULI CENTRAL ELEMENT 2 SEATER	78	180	105/126	1,65	66
BAULI CENTRAL ELEMENT 1 SEATER	78	90	105/126	0,85	36
BAULI CHAISE LONGUE	78	90	170/190	1,35	50
BAULI SQUARED / CORNER FOOTSTOOL	45	105	105	0,50	35
BAULI RECTANGULAR FOOTSTOOL	45	55	105	0,30	20
BAULI CORNER SUPPORT	30	85	28	0,07	2
BAULI HEADREST	28	75	20	0,04	3
BAULI CORNER CUSHION		80	60	0,1	2

- * Corner support, headrests and decor cushions are optional.
- * Backrests can only be with motion.
- * All elements are not connected with joints. Connections can be added under request.
- * Different combination of coverings or different sizes are not previewed in our system. Special requests, if possible, will be considered a "not standard product" and a 10% surcharge will be applied.



Corner Support and
Corner Cushion

_Bauli



Central Element
2 Seater

Headrest





MODERN
COLLECTION

_Beverly



_Beverly

Central Element
2 Seater

Classic Corner

End Element 2 Seater



Recliner

Chaise longue

Classic Corner
(back)



Classic Corner



Moving Corner

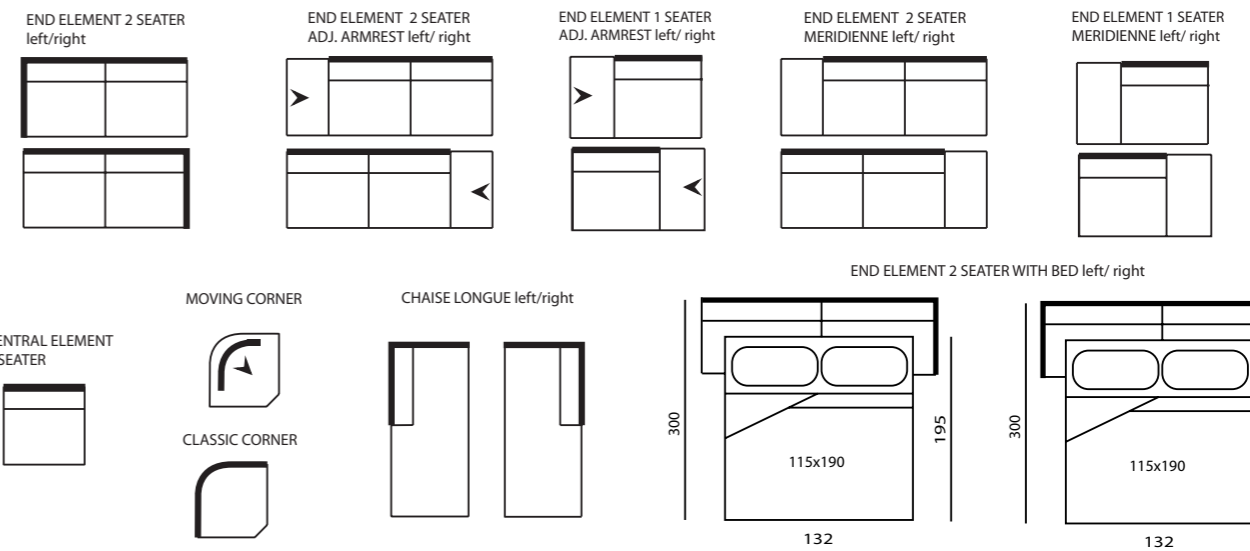

ELEMENTS

	H	L	D	V	W
BEVERLY END ELEMENT 2 SEATER ARMREST ADJUSTABLE*	80/96	165	100	1,35	65
BEVERLY END ELEMENT 1 SEATER ARMREST ADJUSTABLE	80/96	95	100	0,75	45
BEVERLY END ELEMENT 2 SEATER MERIDIENNE	80/96	190	100	1,55	65
BEVERLY END ELEMENT 1 SEATER MERIDIENNE	80/96	120	100	1,00	45
BEVERLY CENTRAL ELEMENT 1 SEATER	80/96	70	100	0,60	40
BEVERLY MOVING CORNER	70	115	115	1,15	35
BEVERLY CLASSIC CORNER	80	115	115	1,15	40
BEVERLY DECOR CUSHION		40	40	0,01	0,5
BEVERLY CHAISE LONGUE	80/96	104	170	1,40	53

- * Electrical recliner, additional battery, corner cushions and decor cushions are optional.
- * Position of headrests is manually adjustable in different angles.
- * Electrical recliner can be added only for end elements without meridienne.
- * Bed version with French pull out net can be added only in the end element 2 seater.
- * Different combination of coverings or different sizes are not previewed in our system. Special requests, if possible, will be considered a "not standard product" and a 10% surcharge will be applied.





MODERN COLLECTION

_Brooklyn



_Brooklyn

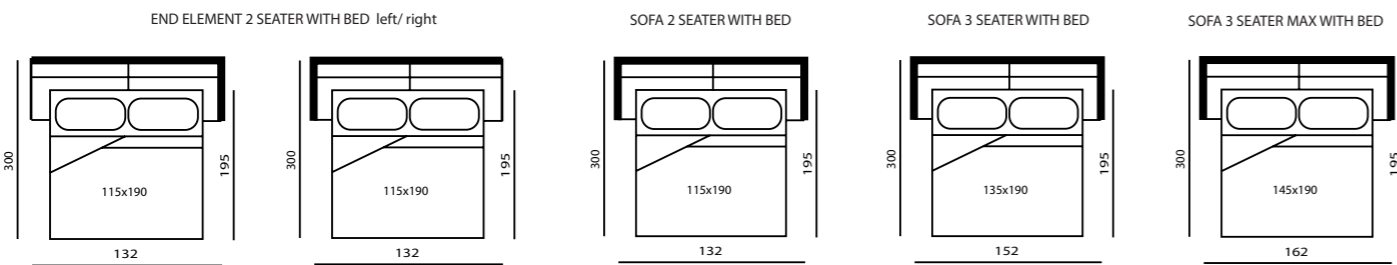
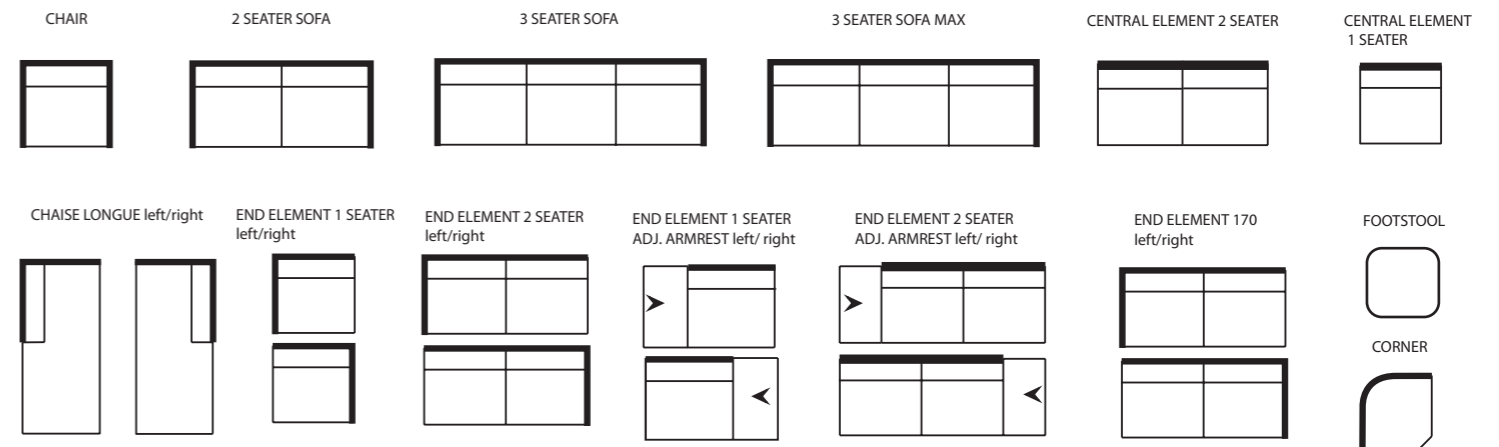

ELEMENTS

	H	L	D	V	W
BROOKLYN END ELEMENT 2 SEATER	96/72	170	110	1,40	60
BROOKLYN END ELEMENT 1 SEATER	96/72	95	110	0,80	40
BROOKLYN CENTRAL ELEMENT 2 SEATER	96/72	140	110	1,10	56
BROOKLYN CENTRAL ELEMENT 1 SEATER	96/72	70	110	0,70	28
BROOKLYN CORNER	72	122	122	1,00	48
BROOKLYN CHAISE LONGUE	96/72	185	110	1,30	65
BROOKLYN END ELEMENT 2 SEATER ADJUSTABLE ARMREST	96/72	195	110	2,00	65
BROOKLYN END ELEMENT 1 SEATER ADJUSTABLE ARMREST	96/72	125	110	1,30	45
BROOKLYN SOFA 3 SEATER MAX	96/72	220	110	2,20	65
BROOKLYN SOFA 3 SEATER	96/72	195	110	1,60	65
BROOKLYN SOFA 2 SEATER	96/72	190	110	2,00	50
BROOKLYN ARMCHAIR	96/72	102	110	0,90	40
BROOKLYN FOOTSTOOL	42	70	70	0,30	15

- * Electrical recliner, additional battery and decor cushions are optional.
- * Bed version is possible in all sofa 3 seater end element 170.
- * Position of headrests is manually adjustable in different angles.
- * Different combination of coverings or different sizes are not previewed in our system. Special requests, if possible, will be considered a "not standard product" and a 10% surcharge will be applied.



MODERN COLLECTION

_California



California

Squared Footstoll + Corner support

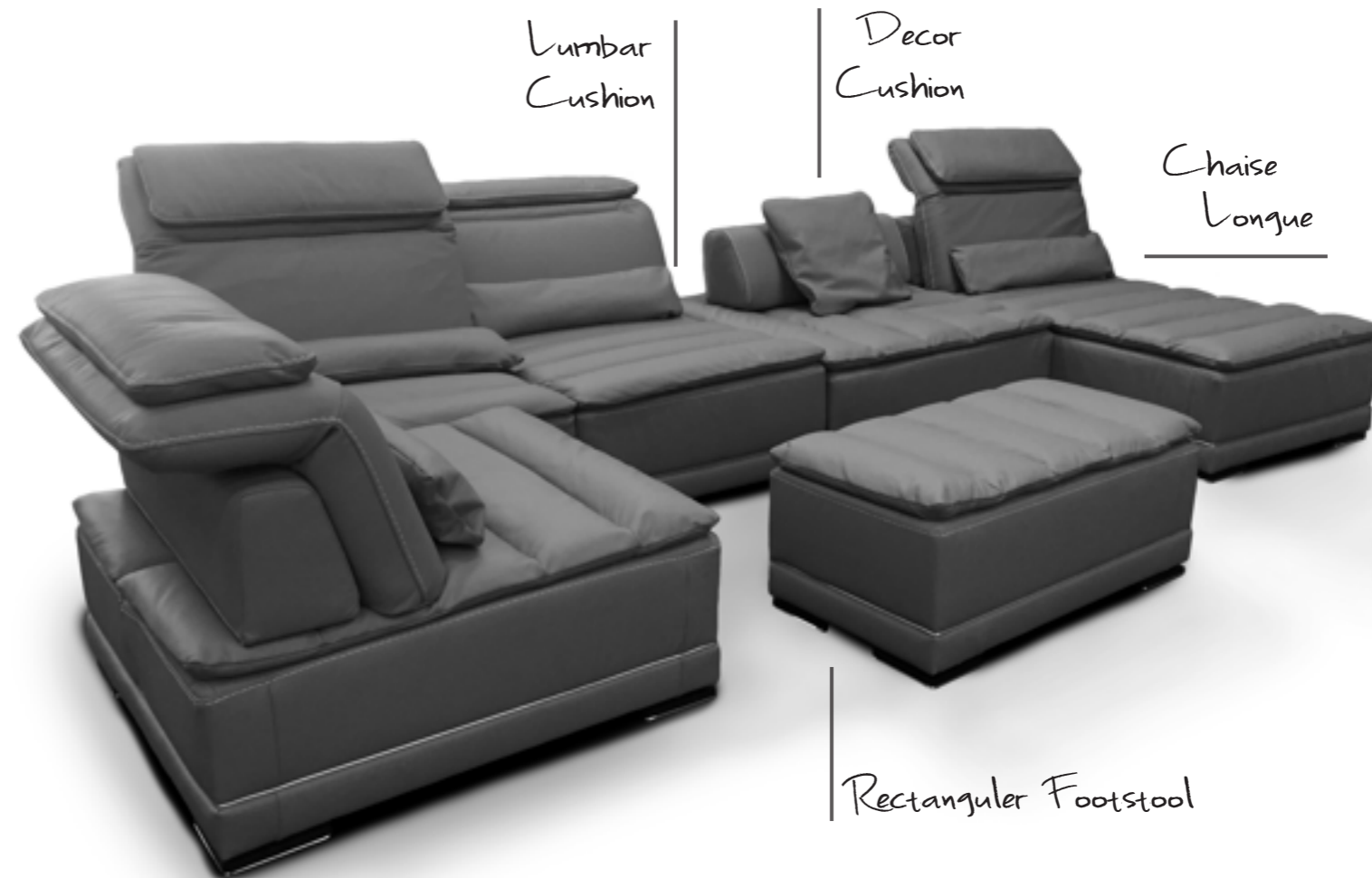

Central Element
2 Seater

Central Element
1 Seater

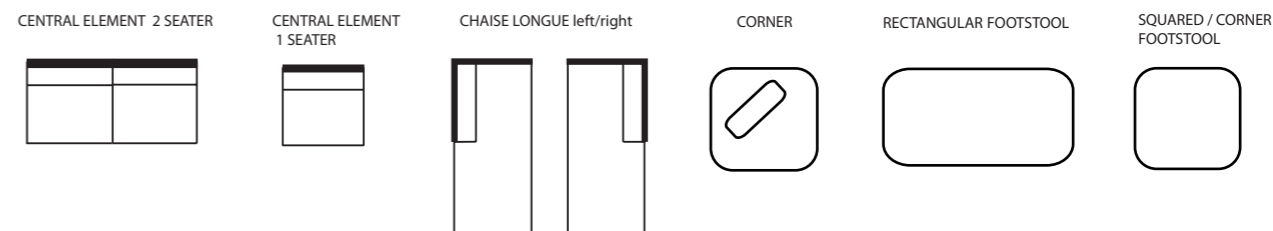

ELEMENTS	H	L	D	V	W
CALIFORNIA CENTRAL ELEMENT 2 SEATER	83/103	180	110/134	1,65	80
CALIFORNIA CENTRAL ELEMENT 1 SEATER	83/103	90	110/134	0,85	50
CALIFORNIA LONGUE CHAIR	83/103	90	176/200	1,35	65
CALIFORNIA SQUARED / CORNER FOOTSTOOL	45	105	105	0,50	35
CALIFORNIA RECTANGULAR FOOTSTOOL	45	55	105	0,30	20
CALIFORNIA CORNER SUPPORT	27	80	25	0,50	30
CALIFORNIA DECOR CUSHION		50	50		
CALIFORNIA LUMBAR CUSHION		80	30		

- * Corner support, lumbar cushions and decor cushions are optional.
- * Backrests can be with motion or fixed.
- * Position of headrests is manually adjustable in different angles.
- * All element are not connected with joints. Connections can be added under request.
- * Different combination of coverings or different sizes are not previewed in our system. Special requests, if possible, will be considered a "not standard product" and a 10% surcharge will be applied.



MODERN
COLLECTION

_Cassandra



Footstool Max



End Element
1 Seater

_Cassandra



Chaise
Longue

Central
Element



Sofa 3 Seater

Footstool

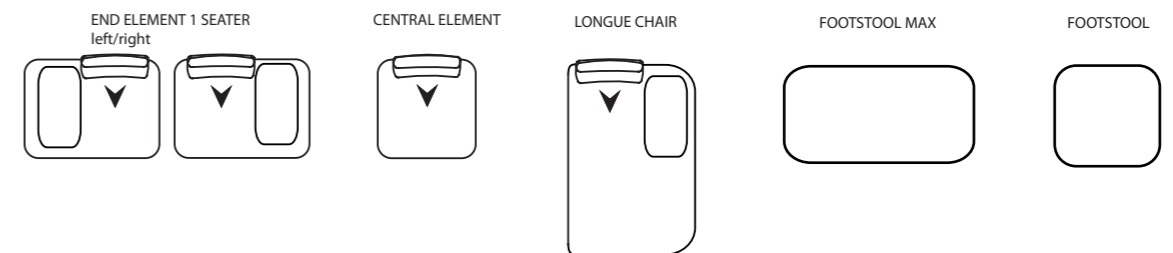

ELEMENTS	H	L	D	V	W
CASSANDRA END ELEMENT1 SEATER	88/96	110	120/135	1,20	65
CASSANDRA CENTRAL ELEMENT	88/96	65	120/135	0,70	50
CASSANDRA CHAISE LONGUE	88/96	115	188/200	1,90	70
CASSANDRA FOOTSTOOL MAX	43	126	72	0,40	20
CASSANDRA FOOTSTOOL	43	72	72	0,25	15
CASSANDRA LUMBAR SUPPORT		60	35		

* Position of headrests and armrests are manually adjustable in different angles.

* Different combination of coverings or different sizes are not previewed in our system. Special requests, if possible, will be considered a "not standard product" and a 10% surcharge will be applied.



MODERN COLLECTION

_Cinemax

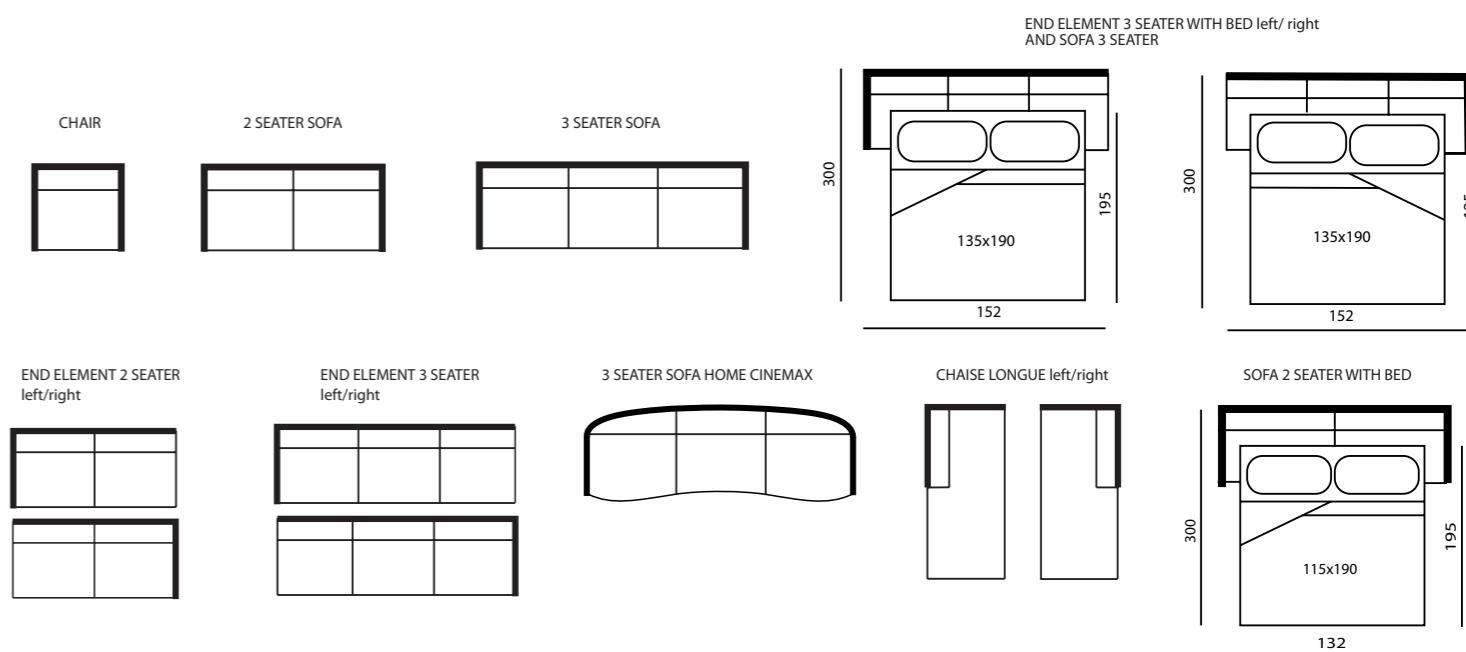

ELEMENTS	H	L	D	V	W
CINEMAX SOFA 3 SEATER HOME CINEMA	100	225	100/170	2,55	90
CINEMAX SOFA 3 SEATER	100	210	100/156	2,10	80
CINEMAX SOFA 2 SEATER	100	170	100/156	1,70	70
CINEMAX ARMCHAIR	100	106	100/156	1,06	50
CINEMAX END ELEMENT 3 SEATER	100	190	100/156	1,90	70
CINEMAX END ELEMENT 2 SEATER	100	150	100/156	1,50	60
CINEMAX CHAISE LONGUE	100	103	170	1,75	55

- * Electrical recliner, additional battery and decor cushions are optional.
- * Bed version is possible in all 2 and 3 seater elements (except home cinema).
- * Position of headrests is manually adjustable for higher laying comfort.
- * For different covering combination please select model Memphis.
- * Different combination of coverings or different sizes are not previewed in our system. Special requests, if possible, will be considered a "not standard product" and a 10% surcharge will be applied.



MODERN COLLECTION

_Compass

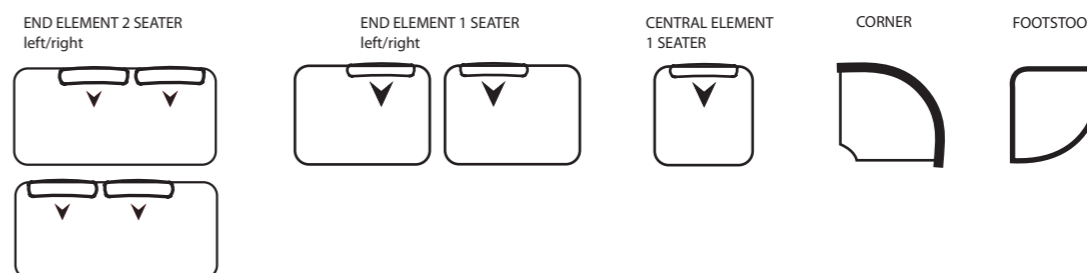

ELEMENTS	H	L	D	V	W
COMPASS END ELEMENT 1 SEATER	83	123	116	1,10	34
COMPASS END ELEMENT 2 SEATER	83	193	116	2,00	58
COMPASS CORNER	83	174	125	1,80	47
COMPASS FOOTSTOOL	41	115	84	0,40	19
COMPASS CENTRAL ELEMENT	83	70	116	0,70	45





- * Movable metal back and forth mechanism for back seats and armrests. Corner back seat fixed.
- * For moving the back seats back and forth slip your hands underneath the back cushions and pull up in vertical and then horizontal movement.
- * Lumbar support pillows included and not removable. They are stitched to the back seat.
- * Rubber profile painted in metal color.
- * Different combination of coverings or different sizes are not previewed in our system. Special requests, if possible, will be considered a "not standard product" and a 10% surcharge will be applied.



MODERN COLLECTION

_Cristina K



	CHAIR	2 SEATER SOFA	3 SEATER SOFA	FOOTSTOOL					
									
ELEMENTS					H	L	D	V	W
CRISTINA SOFA 2 SEATER					82	135	90	1,00	30
CRISTINA SODA 3 SEATER					82	180	90	1,20	40
CRISTINA ARMCHAIR					82	85	90	0,65	22
CRISTINA FOOTSTOOL					38	62	62	0,15	6

- * Back cushion is fixed and stitched to the back seat and can be chosen in the same colors as the inlays (model Cristina).
- * Contrast stitching are standard, tor sur tone stitching can be chosen.
- * The chair can have the roll option.
- * Different combination of coverings or different sizes are not previewed in our system. Special requests, if possible, will be considered a "not standard product" and a 10% surcharge will be applied.



MODERN
COLLECTION

_Dakota





_Dakota

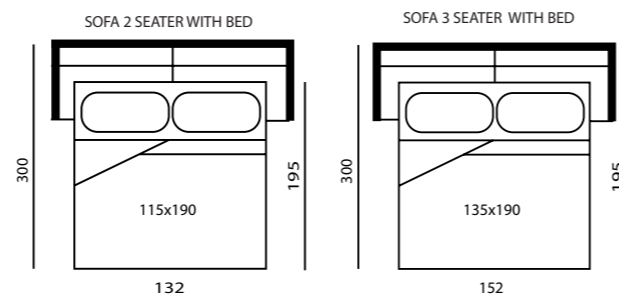

ELEMENTS

	H	L	D	V	W
DAKOTA SOFA 3 SEATER	96	205	95/155	1,90	75
DAKOTA SOFA 2 SEATER	96	170	95/155	1,60	55
DAKOTA ARMCHAIR	96	106	95/155	1,00	40
DAKOTA FOOTSTOOL	47	75	75	0,25	20

- * Electrical recliner, additional battery and decor cushions are optional.
- * Bed version is possible in all 2 and 3 seaters.
- * For different dimentions and compositions please select model Morena.
- * The foostool cannot have any inlays in any other covering or color.
- * Different combination of coverings or different sizes are not previewed in our system. Special requests, if possible, will be considered a "not standard product" and a 10% surcharge will be applied.



MODERN COLLECTION

_Dallas

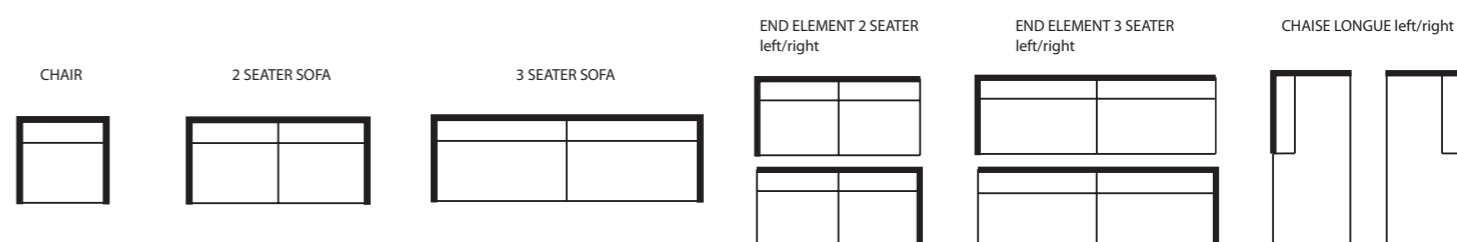
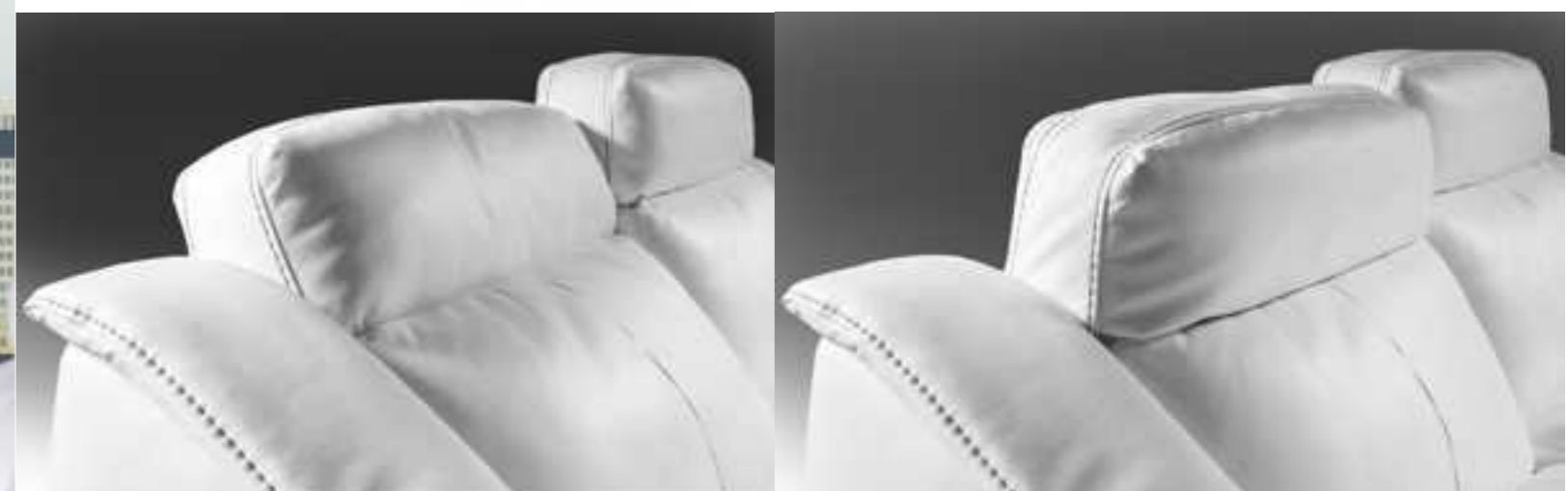

ELEMENTS

	H	L	D	V	W
DALLAS SOFA 3 SEATER	100	205	105	2,15	70
DALLAS SOFA 2 SEATER	100	170	105	1,80	60
DALLAS ARMCHAIR	100	105	105	1,10	50
DALLAS END ELEMENT 3 SEATER	100	185	105	1,95	60
DALLAS TEND ELEMENT 2 SEATER	100	150	105	1,60	55
DALLAS CHAISE LONGUE	100	103	170	1,75	55

- * Electrical recliner, additional battery and decor cushions are optional.
- * Position of headrests is manually adjustable for higher laying comfort.
- * Different combination of coverings or different sizes are not previewed in our system. Special requests, if possible, will be considered a “not standard product” and a 10% surcharge will be applied.



MODERN COLLECTION

_Delia

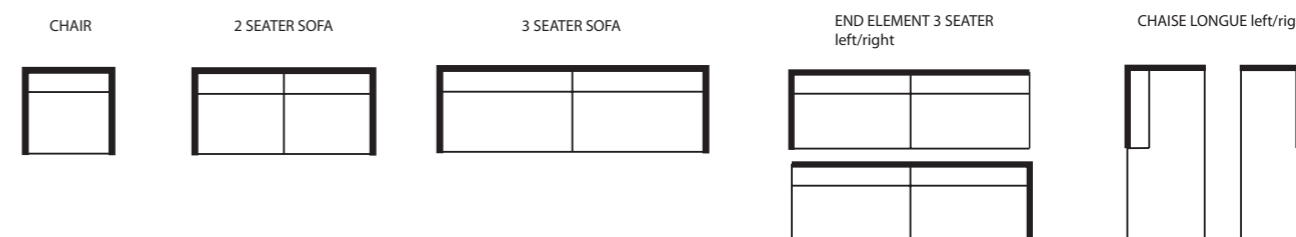

ELEMENTS	H	L	D	V	W
DELIA END ELEMENT 3 SEATER	75/95	185	100/125	1,40	70
DELIA LONGUE CHAIR	75/95	105	170	1,30	58
DELIA SOFA 3 SEATER	75/95	205	100	1,55	80
DELIA SOFA 2 SEATER	75/95	175	100	1,35	70
DELIA ARMCHAIR	75/95	102	100	0,80	40
DELIA CUSHION		70	20		

- * Decor cushions are optional.
- * Position of headrests is manually adjustable in different angles.
- * Metal legs are made of stainless steel and cannot be changed.
- * Different combination of coverings or different sizes are not previewed in our system. Special requests, if possible, will be considered a "not standard product" and a 10% surcharge will be applied.

_Delia





MODERN COLLECTION

_Dominique



Headrest



Corner End Element
Meridienne

End Element
2 Seater



2 SEATER SOFA



3 SEATER SOFA

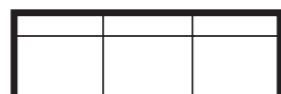

CENTRAL ELEMENT
1 SEATER



FOOTSTOOL

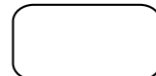

CHAISE LONGUE left/right

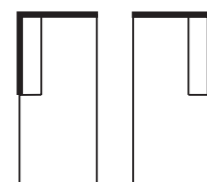

END ELEMENT 2 SEATER
left/right

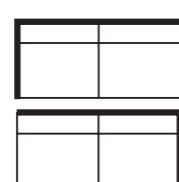

END ELEMENT 3 SEATER
left/right

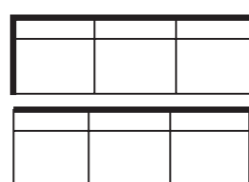

CORNER END ELEMENT MERIDIENNE
left/right

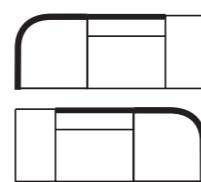

ELEMENTS

	H	L	D	V	W
DOMINIQUE SOFA 3 SEATER	71	210	102	1,55	70
DOMINIQUE SOFA 2 SEATER	71	190	102	1,40	65
DOMINIQUE CENTRAL ELEMENT 1 SEATER	71	70	102	0,50	35
DOMINIQUE END ELEMENT 3 SEATER	71	185	102	1,35	65
DOMINIQUE END ELEMENT 2 SEATER	71	165	102	1,20	70
DOMINIQUE CORNER END ELEMENT MERIDIENNE	71	220	104	1,65	65
DOMINIQUE LONGUE CHAIR	71	175	120	1,50	65
DOMINIQUE FOOTSTOOL	41	70	60	0,20	15
DOMINIQUE HEADREST	26	60	8	0,01	5

* Headrests are removable and are optional.

* Different combination of coverings or different sizes are not previewed in our system. Special requests, if possible, will be considered a "not standard product" and a 10% surcharge will be applied.



MODERN COLLECTION

_Espace



_Espace

Round Seat

3 Seater Sofa

2 Seater Sofa

Sofa Footstool

Oval Table



_Espace

ELEMENTS	H	L	D	V	W
ESPACE ROUND SEAT XXL	80	150	154	1,90	80
ESPACE ROUND SEAT G (TURNING)	80	150	154	1,90	86
ESPACE SOFA 175	78	175	110	1,50	60
ESPACE SOFA 2 SEATER	78	211	110	1,85	70
ESPACE SOFA 3 SEATER	78	241	110	2,10	79
ESPACE DROP SHADED FOOTSTOOL RIGHT / LEFT	42	130	68	0,30	24
ESPACE SOFA/FOOTSTOOL	43	160	73	0,60	30
ESPACE CHAISE LONGUE RIGHT / LEFT	80	197	122	1,95	68
ESPACE BACK CUSHION	50	60	50	0,01	2
ESPACE OVAL TABLE WITH TOP GLASS	37	165	98	0,60	58



Chaise Longue

Drop Shaped Footstool

_Norma

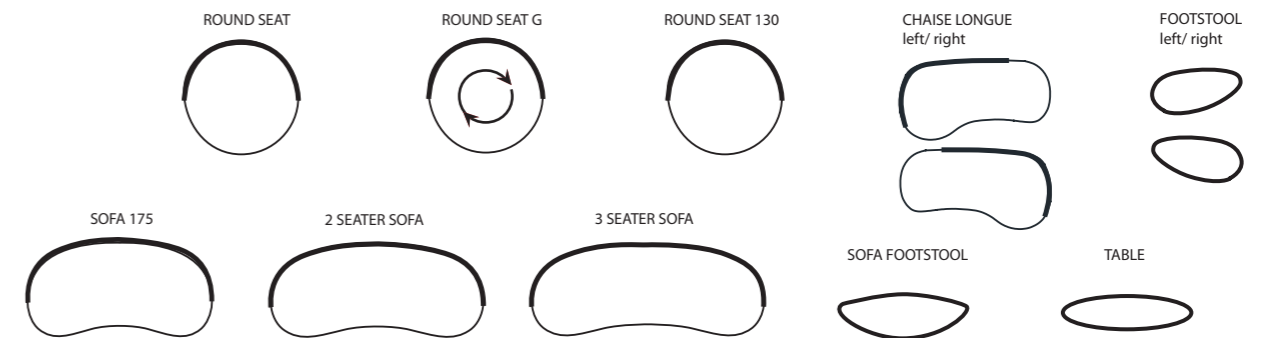

ELEMENTS	H	L	D	V	W
NORMA ROUND SEAT 130	76	130	134	1,35	60
NORMA FOOTSTOOL	42	90	70	0,25	23

- * Light padding piece of furniture (please see sales conditions).
- * Rubber profile painted in metal color.
- * The 3 seater includes 4 back cushions 52x62 cm in a chosen covering of our collection.
- * The 2 seater includes 4 back cushions 52x62 cm in a chosen covering of our collection.
- * The Round Seat includes 4 back cushions 52x62 cm in a chosen covering of our collection.
- * Round table upper glass in smoked black color (not to be chosen).
- * Different combination of coverings or different sizes are not previewed in our system. Special requests, if possible, will be considered a "not standard product" and a 10% surcharge will be applied.



MODERN COLLECTION

_Galaxy



END ELEMENT 3 SEATER left/right

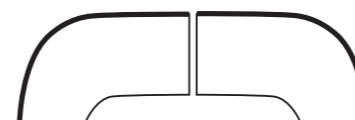

CENTRAL FOOTSTOOL



LATERAL FOOTSTOOL left/right

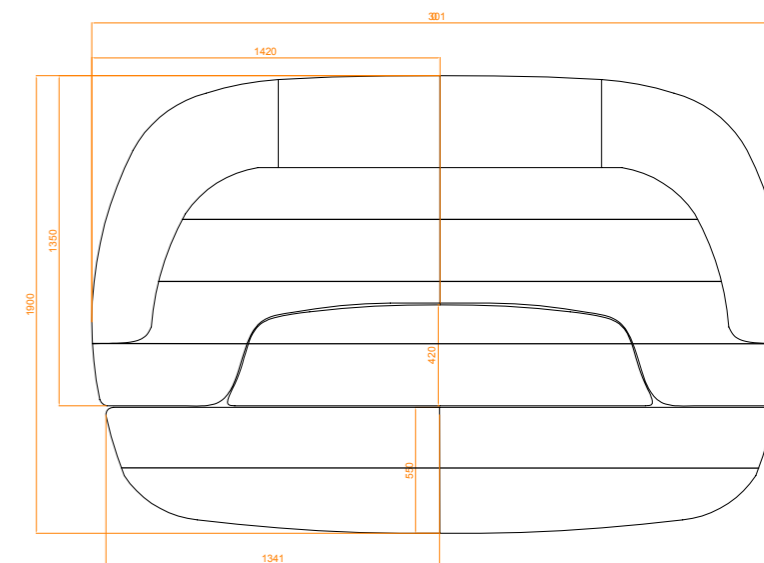

ELEMENTS

	H	L	D	V	W
GALAXY 3 SEATER LEFT WITH HEADREST	85	155	135	1,80	49
GALAXY 3 SEATER RIGHT WITH HEADREST	85	155	135	1,80	49
GALAXY FOOTSTOOL LEFT	42	145	55	0,40	20
GALAXY FOOTSTOOL RIGHT	42	145	55	0,40	20
GALAXY CENTRAL FOOTSTOOL	42	165	42	0,30	20

* Movable Headrest is only in the 2 central backseats.

* The composition can be sold also separately.

* Different combination of coverings or different sizes are not previewed in our system. Special requests, if possible, will be considered a "not standard product" and a 10% surcharge will be applied.



_Kespace

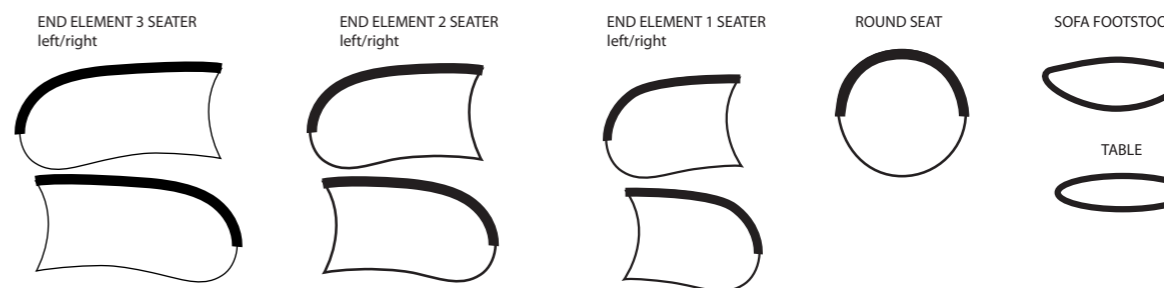

ELEMENTS	H	L	D	V	W
KESPACE END ELEMENT 1 SEATER RIGHT	78	115	110	0,90	40
KESPACE END ELEMENT 1 SEATER LEFT	78	115	110	0,90	40
KESPACE END ELEMENT 2 SEATER RIGHT	78	170	110	1,50	50
KESPACE END ELEMENT 2 SEATER LEFT	78	170	110	1,50	50
KESPACE END ELEMENT 3 SEATER RIGHT	78	200	110	1,80	57
KESPACE END ELEMENT 3 SEATER LEFT	78	200	110	1,80	57
KESPACE ROUND SEAT	80	150	154	1,85	80
KESPACE SOFA FOOTSTOOL	45	150	135	0,60	24
KESPACE OVAL TABLE WITH TOP GLASS	37	165	98	0,60	58

- * Rubber profile painted in metal color.
- * The end element 2 seater includes 3 back cushions 52x62 cm in a chosen covering of our collection.
- * The end element 3 seater includes 4 back cushions 52x62 cm in a chosen covering of our collection.
- * The Round Seat includes 4 back cushions 52x62 cm in a chosen covering of our collection.
- * Different combination of coverings or different sizes are not previewed in our system. Special requests, if possible, will be considered a "not standard product" and a 10% surcharge will be applied.



MODERN
COLLECTION

_Kosmos



_Kosmos

3 Seater



End Element
2 Seater



Chaise Longue
Round

4 Seater

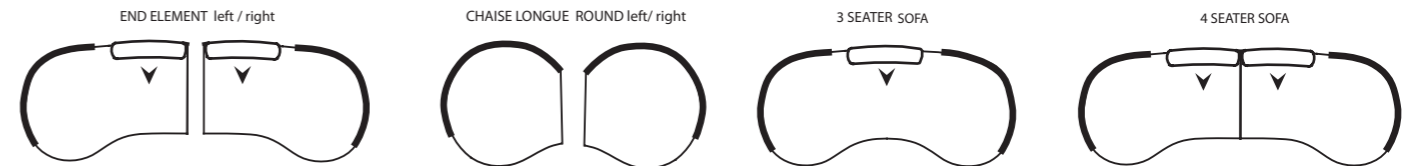

ELEMENTS	H	L	D	V	W
KOSMOS SOFA 3 SEATER	84	235	143	2,80	84
KOSMOS SOFA 4 SEATER	84	304	143	3,00	114
KOSMOS END ELEMENT 2 SEATER RIGHT	84	152	143	1,90	58
KOSMOS END ELEMENT 2 SEATER LEFT	84	152	143	1,90	58
KOSMOS CHAISE LONGUE ROUND RIGHT	84	139	168	1,96	58
KOSMOS CHAISE LONGUE ROUND LEFT	84	139	168	1,96	58

- * Only the central backseats of the 2 seater element with lumbar support have a movable backrest to adjust seat depth. To move the back seat back and forth slip your hands underneath the back cushions and pull up in vertical movement. Do not push or pull without lifting the backseat at the same time.
- * Rubber profile painted in metal color.
- * The 2 end elements 2 seater right and left includes 1 back cushion 52x62 cm and 1 lumbar support 55X30 each in a chosen covering of our collection.
- * The 3 seater includes 2 back cushions 52x62 cm and 1 lumbar support 55X30 in a chosen covering of our collection
- * The 4 seater it's a combination of 2 end elements 2 seater right and left and includes 2 back cushions 52x62 cm and 2 lumbar support 55X30 in a chosen covering of our collection.
- * The Chaise Longue Round includes 1 back cushion 55x50 cm and 1 décor cushion 40x40 cm and 1 lumbar support 55X30 in a chosen covering of our collection.
- * It is possible to order extra décor cushions or lumbar support.
- * Different combination of coverings or different sizes are not previewed in our system. Special requests, if possible, will be considered a "not standard product" and a 10% surcharge will be applied.



MODERN COLLECTION

_Lipari

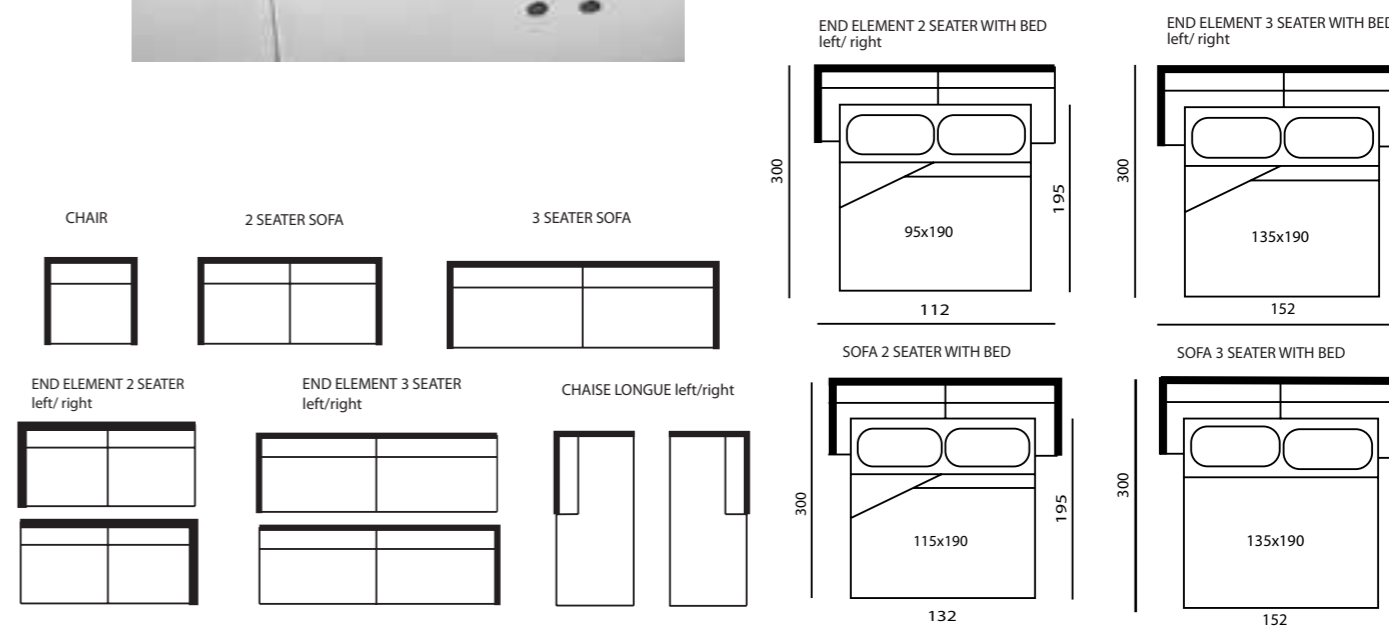

ELEMENTS

	H	L	D	V	W
LIPARI SOFA 3 SEATER	95/110	205	100	1,95	80
LIPARI SOFA 2 SEATER	95/110	170	100	1,60	70
LIPARI ARMCHAIR	95/110	105	100	1,00	50
LIPARI END ELEMENT 3 SEATER	95/110	185	100	1,70	70
LIPARI END ELEMENT 2 SEATER	95/110	150	100	1,35	60
LIPARI CHAISE LONGUE	95/110	103	170	1,65	55

- * Electrical recliner, additional battery and decor cushions are optional.
- * Bed version is possible in all 2 and 3 seater elements.
- * Position of headrests is manually adjustable for higher laying comfort.
- * Different combination of coverings or different sizes are not previewed in our system. Special requests, if possible, will be considered a "not standard product" and a 10% surcharge will be applied.



MODERN COLLECTION

_Louis

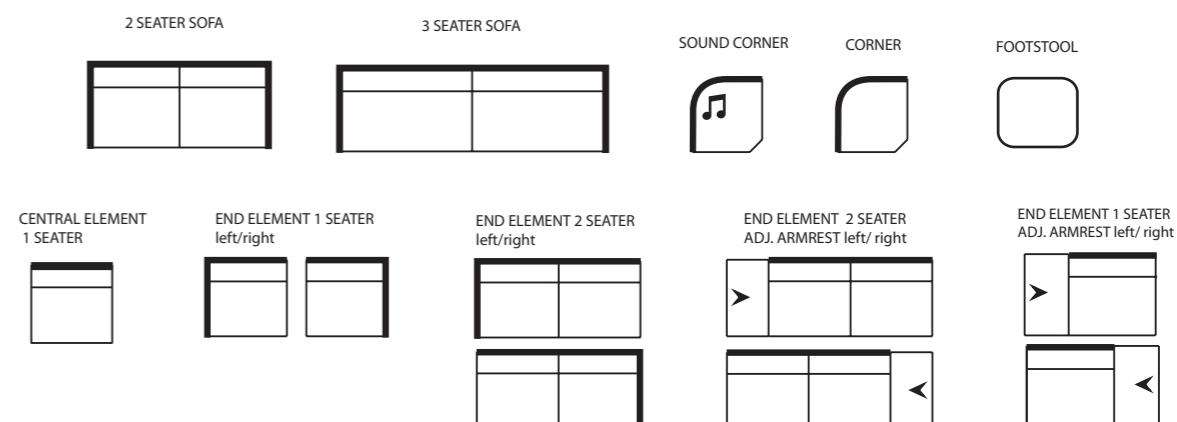

ELEMENTS	H	L	D	V	W
LOUIS END ELEMENT 1 SEATER ADJUSTABLE ARMREST	72/96	120	110	0,95	55
LOUIS END ELEMENT 2 SEATER ADJUSTABLE ARMREST	72/96	190	110	1,50	70
LOUIS END ELEMENT 1 SEATER	72/96	100	110	1,10	50
LOUIS END ELEMENT 2 SEATER	72/96	170	110	1,40	60
LOUIS CENTRAL ELEMENT	72/96	70	110	0,70	35
LOUIS CORNER	56	122	122	0,85	50
LOUIS SOUND CORNER	56	122	122	0,85	55
LOUIS FOOTSTOOL	37	90	60	0,20	13
LOUIS SOFA 3 SEATER	72/96	230	110	1,80	65
LOUIS SOFA 2 SEATER	72/96	200	110	1,60	55

- * Adjustable headrests are a characteristic of each piece, with or without recliner. In order not to break the internal headrests mechanism we suggest to lift up the headrest adjust it in one of the 3 possible positions and to bring it back, push it forward till you feel the mechanism soften and bring it back in horizontal position.
- * Loose pillows are not included in the composition. In case you order a Corner Element we recommend choosing also the corresponding back seat loose pillows 40x40 cm.
- * Corner Sound or Sound Storage devices can be used to reproduce MP3, iPhones, iPods etc.
- * Different combination of coverings or different sizes are not previewed in our system. Special requests, if possible, will be considered a "not standard product" and a 10% surcharge will be applied.



MODERN
COLLECTION

_Madison



_Madison

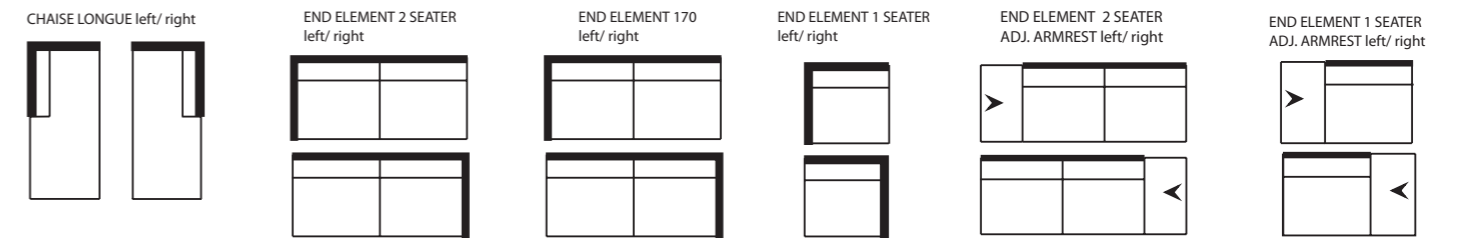
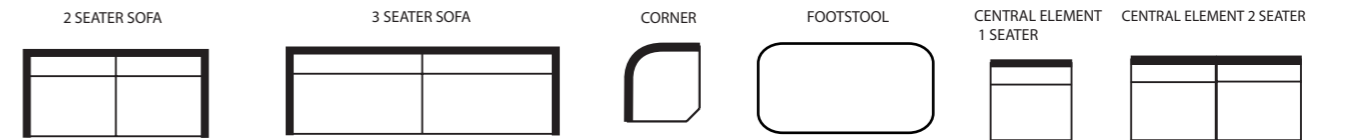

ELEMENTS

	H	L	D	V	W
MADISON END ELEMENT 2 SEATER 170	96/72	170	110	1,40	60
MADISON END ELEMENT 1 SEATER	96/72	95	110	0,80	40
MADISON CENTRAL ELEMENT 2 SEATER	96/72	140	110	1,10	56
MADISON CENTRAL ELEMENT 1 SEATER	96/72	70	110	0,70	28
MADISON CORNER	72	122	122	1,00	48
MADISON END ELEMENT 2 SEATER ADJUSTABLE ARMREST	96/72	195	110	1,80	75
MADISON END ELEMENT 1 SEATER ADJUSTABLE ARMREST	96/72	125	110	1,30	65
MADISON RECTANGULAR FOOTSTOOL	42	110	50	1,25	20
MADISON CHAISE LONGUE	96/72	185	110	1,30	65
MADISON 3 SEATER MAX	96/72	215	110	1,80	75
MADISON SOFA 3 SEATER	72/96	195	110	1,60	70
MADISON SOFA 2 SEATER	96/72	185	110	1,30	65

END ELEMENT 170 WITH BED left/ right

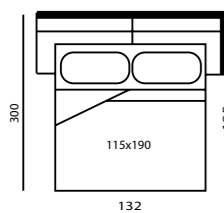

SOFA 2 SEATER WITH BED

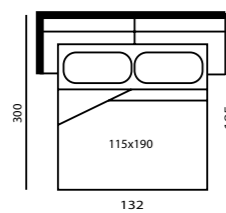

SOFA 3 SEATER WITH BED

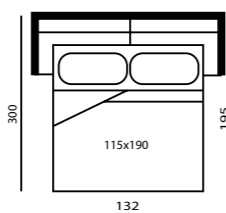

SOFA 3 SEATER MAX WITH BED

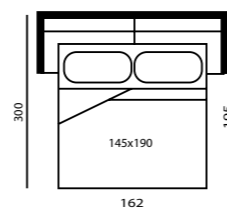
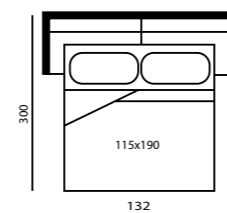

- * Electrical recliner, additional battery and decor cushions are optional.
- * Bed version is possible in end element 2 seater and in sofa 3 seater.
- * Position of headrests is manually adjustable for higher laying comfort.
- * Corner element cannot have adjustable headrests.
- * End element with adjustable armrests cannot have the recliner function.
- * Different combination of coverings or different sizes are not previewed in our system. Special requests, if possible, will be considered a "not standard product" and a 10% surcharge will be applied.



MODERN COLLECTION

_Manchester



_Manchester



2 SEATER SOFA

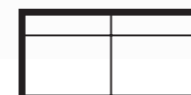

3 SEATER SOFA

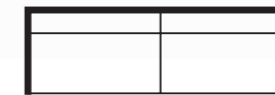

ELEMENTS

	H	L	D	V	W
MANCHESTER SOFA 3 SEATER	80	222	95	1,70	59
MANCHESTER SOFA 2 SEATER	80	192	95	1,50	53

* The wood base will be finished in wengè color if not differently chosen.

* Different combination of coverings or different sizes are not previewed in our system. Special requests, if possible, will be considered a "not standard product" and a 10% surcharge will be applied.



MODERN COLLECTION

_Marathon

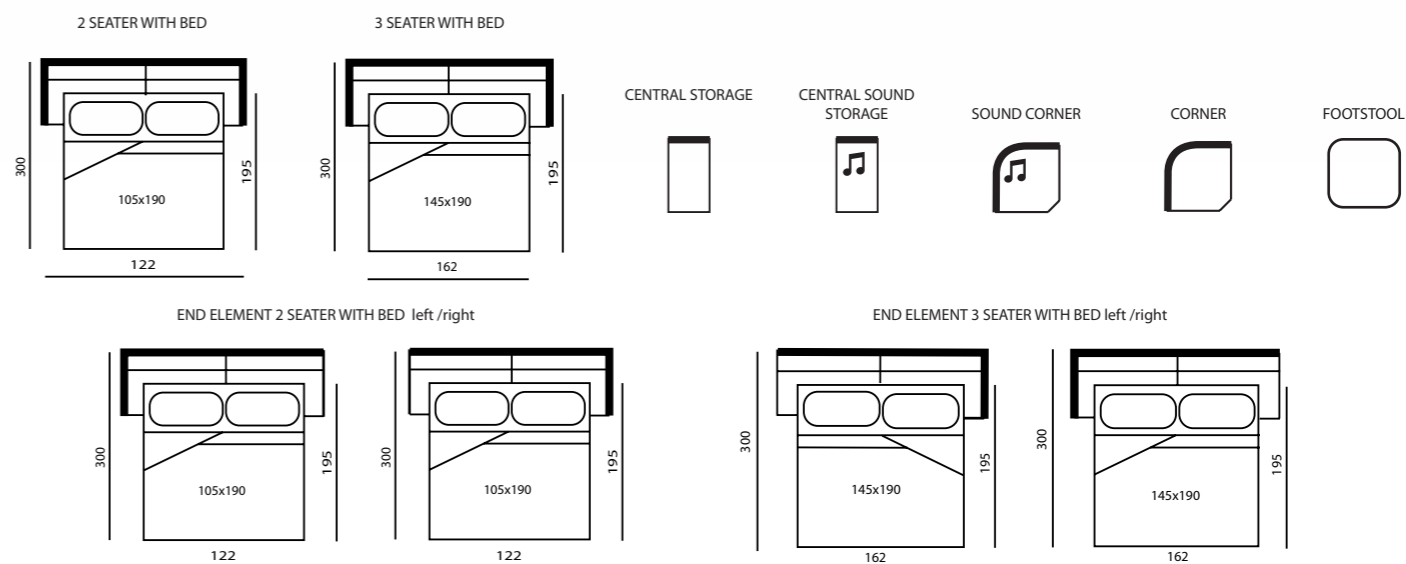
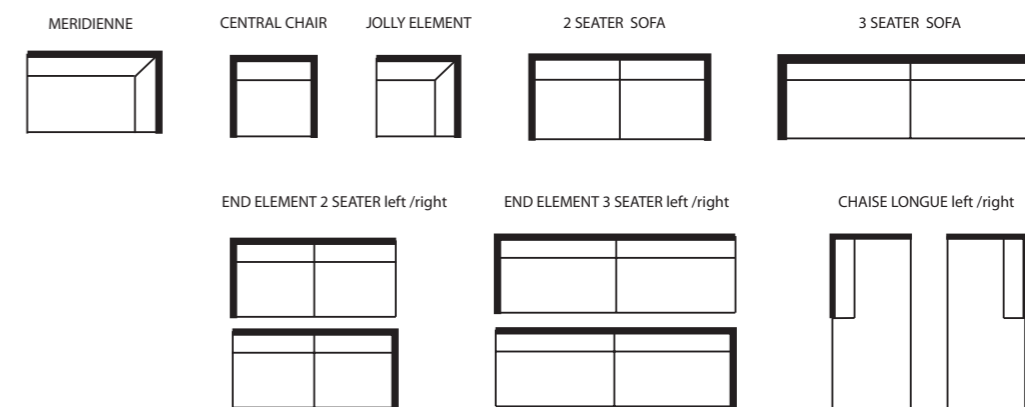

_Marathon

ELEMENTS

	H	L	D	V	W
MARATHON SOFA 2 SEATER	84	191	106	1,70	67
MARATHON SOFA 3 SEATER	84	240	106	2,15	73
MARATHON CHAISE LONGUE	84	120	174	1,75	49
MARATHON CENTRAL CHAIR WITH ARMRESTS	84	103	103	0,90	35
MARATHON JOLLY ELEMENT	84	103	103	0,90	31
MARATHON SOUND CORNER	56	122	122	1,15	55
MARATHON CORNER	56	122	122	1,15	50
MARATHON BACK CUSHION JOLLY/CENTRAL		60	50	0,01	5
MARATHON SMALL BACK CUSHION		40	40	0,01	3
MARATHON MERIDIENNE	84	103	173	1,50	49
MARATHON FOOTSTOOL	38	103	103	0,40	23
MARATHON STORAGE	72	48	110	0,30	20
MARATHON STORAGE SOUND	72	48	110	0,30	25
MARATHON END ELEMENT 2 SEATER	84	160	106	1,50	65
MARATHON END ELEMENT 3 SEATER	84	207	106	1,90	69



* Back seat cushions are included in the price and can be chosen in all coverings of our collection.

BACKREST CUSHIONS DIMENTIONS:

- For 3 seater + End. elem. 3s + chaise longue = 90x50 cm
- For Central, Jolly Element and Meridienne = 60x50 cm
- For End element 2 seater , central element, 2 seater = 70x50 cm
- Decor Cushions: Suitable for all elements = 40x40 cm

- * The upper seat cushions is removable and changeable but only as a unique piece with covering and foam.
- * The back part of the sets is open, and the back cushions are sustained by a padded structure and by metal bars. We recommend never to seat on the back frame.
- * All 2 and 3 seater elements can have a bed version. The bed version has a French bed mechanism with orthopedic mattress easy to pull out by removing the upper seat cushions.
- * The sound system works with MP3, Wave, iPods and Iphone 4 (for upper version you need an adaptor) and can be placed only in the Corner element and the Central Storage.
- * Different combination of coverings or different sizes are not previewed in our system. Special requests, if possible, will be considered a "not standard product" and a 10% surcharge will be applied.



MODERN
COLLECTION

_Matisse



_Matisse

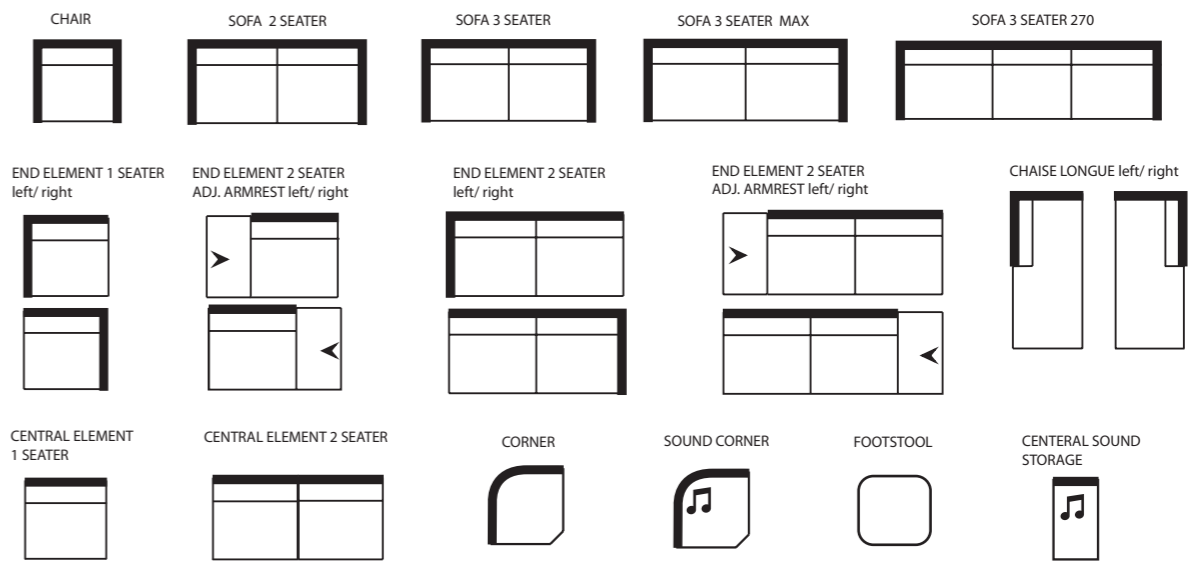

ELEMENTS	H	L	D	V	W
MATISSE ARMCHAIR*	72/96	102	110	0,90	35
MATISSE SOFA 2 SEATER*	72/96	190	110	1,60	55
MATISSE SOFA 3 SEATER*	72/96	215	110	1,80	75
MATISSE SOFA 3 SEATER MAX*	72/96	225	110	1,80	65
MATISSE SOFA MAX 270*	72/96	270	110	2,20	80
MATISSE END ELEMENT 2 SEATER*	72/96	170	110	1,40	60
MATISSE END ELEMENT 1 SEATER*	72/96	100	110	0,90	50
MATISSE END ELEMENT 1 SEATER WITH MOVABLE ARMREST	72/96	120	110	0,95	50
MATISSE END ELEMENT 2 SEATER WITH MOVABLE ARMREST	72 /96	185	110	1,50	60
MATISSE CENTRAL ELEMENT*	72/96	70	110	0,55	28
MATISSE CENTRAL ELEMENT 2 SEATER*	72/96	140	110	1,10	50
MATISSE CHAISE LONGUE	72/96	97	183	1,30	50
MATISSE CORNER	56	122	122	1,00	46
MATISSE SOUND CORNER	56	122	122	1,00	50
MATISSE BACK CUSHION	5	50	50	0,01	2
MATISSE FOOTSTOOL	42	90	60	0,20	15
MATISSE STORAGE	72	48	110	0,40	15
MATISSE STORAGE SOUND	72	48	110	0,40	25

_Matisse L.
MATISSE BED VERSION

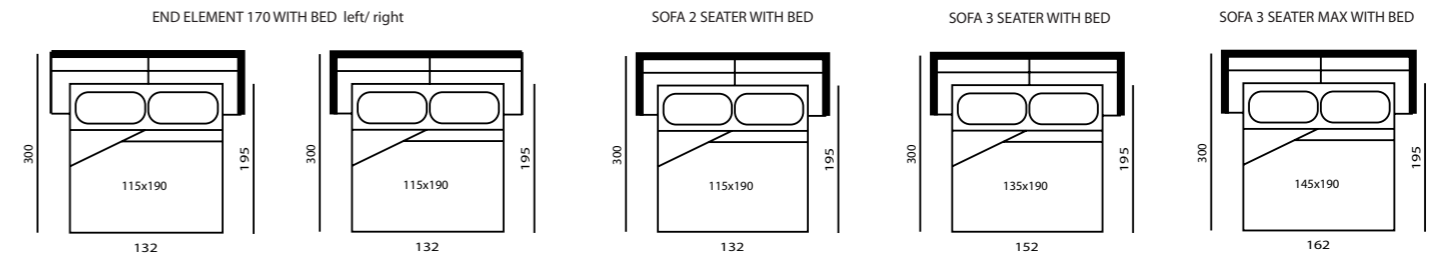

- * Electrical recliner, additional battery and decor cushions are optional.
- * Manually adjustable headrests are a characteristic of each piece, with or without recliner. In order not to break the internal headrests mechanism we suggest to lift up the headrest adjust it in one of the 3 possible positions and to bring it back, push it forward till you feel the mechanism soften and bring it back in horizontal position.
- * When recliner mechanism is chosen for a central seat or for an internal element the touch up buttons are hidden between the seat cushions.
- * In case you order a fixed end element and a recliner or bed element to join with it is possible that the balance of the whole sofa is not stable due to the different weights of the elements.
- * In case of multiple recliners in a same composition plugs will be multiple. It is not possible to plug in all elements with the same plug.
- * Loose pillows are not included in the composition. In case you order a Corner Element please also choose the corresponding back seat loose pillows 50x50 cm.
- * All 2 and 3 seater elements can have a bed version. The bed version has a French bed mechanism with orthopedic mattress easy to pull out by removing the upper seat cushions.
- * The sound system works with MP3, Wave, IPods and Iphone 4 (for upper version you need an adaptor) and can be placed only in the Corner element and the Central Storage.
- * Different combination of coverings or different sizes are not previewed in our system. Special requests, if possible, will be considered a "not standard product" and a 10% surcharge will be applied.





MODERN COLLECTION

_Maud



ELEMENTS	H	L	D	V	W
MAUD SOFA 3 SEATER	74/94	225	105	1,75	80
MAUD SOFA 2 SEATER	74/94	185	105	1,45	70
MAUD ARMCHAIR	74/94	100	105	0,80	50

- * Position of headrests is manually adjustable in different angles.
- * Legs are in chromed stainless steel and cannot be changed.
- * Seat cushions are removable.
- * Different combination of coverings or different sizes are not previewed in our system. Special requests, if possible, will be considered a "not standard product" and a 10% surcharge will be applied.



MODERN COLLECTION

_Memphis

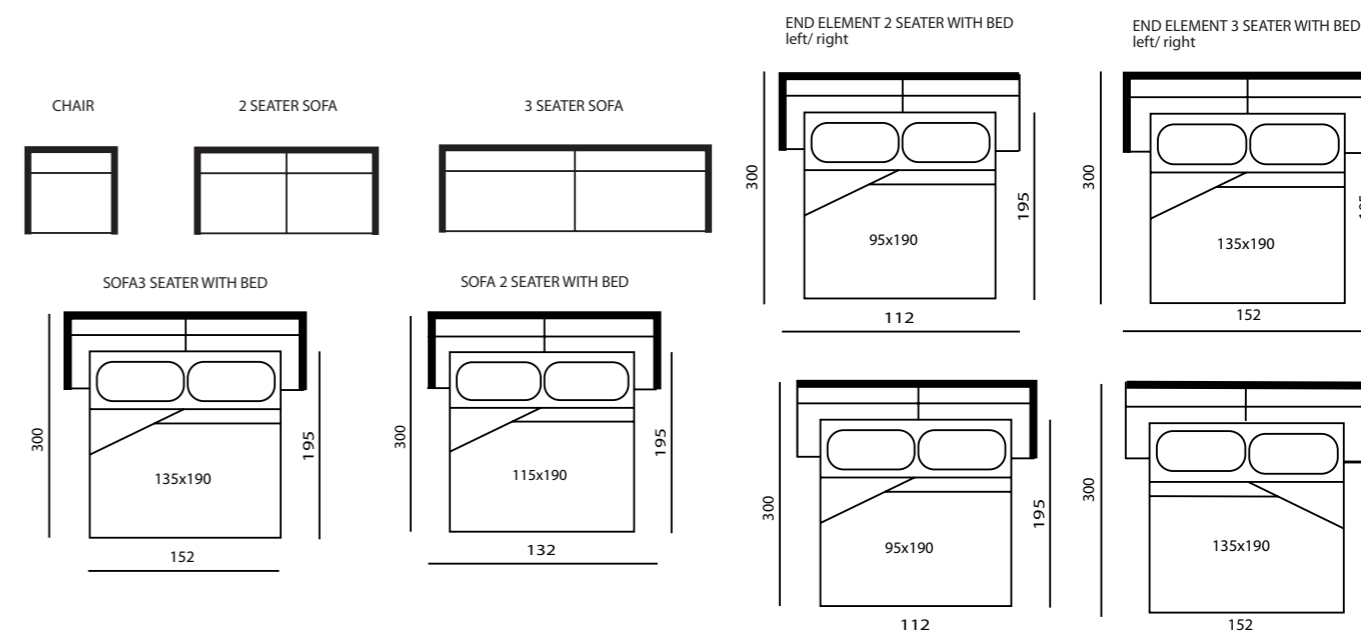

ELEMENTS

	H	L	D	V	W
MEMPHIS SOFA 3 SEATER	100	210	100/156	2,10	80
MEMPHIS SOFA 2 SEATER	100	170	100/156	1,70	70
MEMPHIS ARMCHAIR	100	106	100/156	1,06	50
MEMPHIS END ELEMENT 3 SEATER	100	190	100/156	1,90	70
MEMPHIS END ELEMENT 2 SEATER	100	150	100/156	1,50	60
MEMPHIS LONGUE CHAIR	100	103	170	1,75	55

- * Electrical recliner, additional battery and decor cushions are optional.
- * Position of headrests is manually adjustable for higher laying comfort.
- * Bed version is possible in all 2 and 3 seater elements.
- * For different combination of coverings and for Home Cinema version please see model Cinemax.
- * For different dimensions and compositions please select model Cinemax.
- * Different combination of coverings or different sizes are not previewed in our system. Special requests, if possible, will be considered a "not standard product" and a 10% surcharge will be applied.



MODERN COLLECTION

_Metropolitan



_Metropolitan



ELEMENTS	H	L	D	V	W
METROPOLITAN SOFA 2 SEATER	69	200	105	1,50	77
METROPOLITAN SOFA 3 SEATER	69	230	105	1,70	86
METROPOLITAN CHAISE LONGUE	69	128	164	1,45	54
METROPOLITAN CENTRAL ELEMENT/ CHAIR	69	92	102	0,60	30
METROPOLITAN END ELEMENT 1 SEATER	69	126	105	0,90	47
METROPOLITAN END ELEMENT 2 SEATER	69	170	105	1,30	49
METROPOLITAN END ELEMENT 3 SEATER	69	200	105	1,50	75
METROPOLITAN FOOTSTOOL	41	60	70	0,20	15
METROPOLITAN BACK CUSHIONS		62	52		
DECOR CUSHION		35	35		
METROPOLITAN HEADREST		78	34		

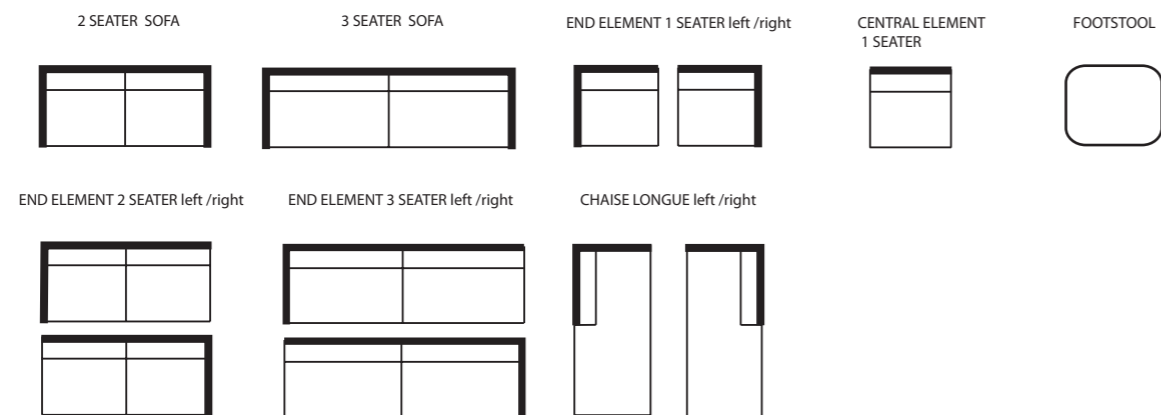

- * Headrests and decor cushions 40x40 cm are optional.
- * The central element can be used as an armless chair and can be connected with joints to the end elements under request.
- * Contrast thread stitching is standard when body is in leather or fabric.
- * Headrests and decor cushions needs to be ordered separately.
- * Different combination of coverings or different sizes are not previewed in our system. Special requests, if possible, will be considered a "not standard product" and a 10% surcharge will be applied.



MODERN COLLECTION

_Mexico



ELEMENTS	H	L	D	V	W
MEXICO SOFA 3 SEATER	78/92	216	100	1,70	80
MEXICO SOFA 2 SEATER	78/92	176	100	1,40	70
MEXICO ARMCHAIR	78/92	106	100	0,85	50
MEXICO FOOTSTOOL	43	85	85	0,30	20

- * Position of headrests is manually adjustable in different angles.
- * Legs are in chromed stainless steel and cannot be changed.
- * Different combination of coverings or different sizes are not previewed in our system. Special requests, if possible, will be considered a "not standard product" and a 10% surcharge will be applied.



MODERN COLLECTION

_Miami



2 SEATER SOFA

3 SEATER SOFA

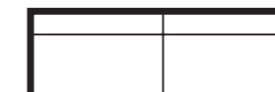

ELEMENTS

	H	L	D	V	W
MIAMI SOFA 3 SEATER	90/108	230	110	2,30	80
MIAMI SOFA 2 SEATER	90/108	190	110	1,90	70

- * Electrical recliner, additional battery and decor cushions are optional.
- * Position of headrests is manually adjustable for higher laying comfort
- * Legs are in chromed stainless steel and cannot be changed.
- * Different combination of coverings or different sizes are not previewed in our system. Special requests, if possible, will be considered a “not standard product” and a 10% surcharge will be applied.



MODERN COLLECTION



_Morena

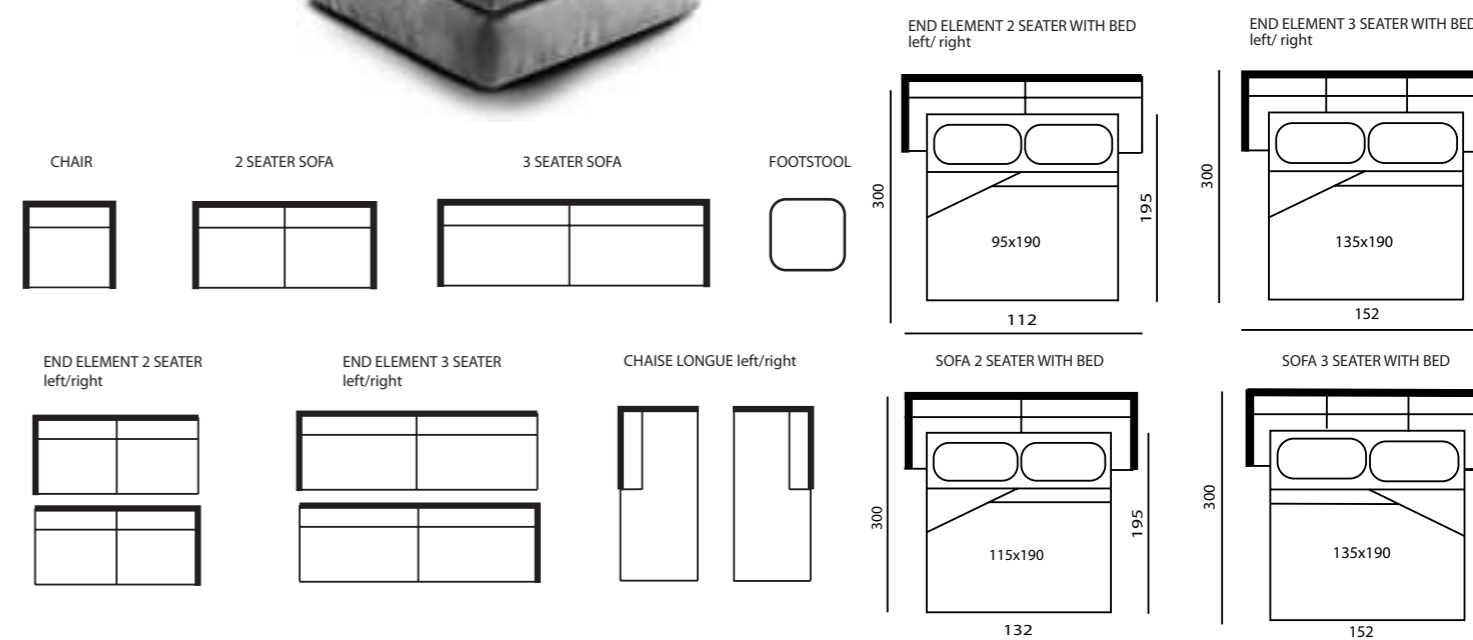

ELEMENTS

ELEMENTS	H	L	D	V	W
MORENA SOFA 3 SEATER	100	210	105	2,20	75
MORENA SOFA 2 SEATER	100	175	105	1,85	65
MORENA ARMCHAIR	100	115	105	1,30	50
MORENA FOOTSTOOL	47	75	75	0,25	20
MORENA END ELEMENT 3 SEATER	100	175	105	1,85	65
MORENA END ELEMENT 2 SEATER	100	150	105	1,55	55
MORENA CHAISE LONGUE	100	105	170	1,80	50

- * Electrical recliner, additional battery and decor cushions are optional.
- * Bed version is possible in all 2 and 3 seater elements.
- * For different dimensions and compositions please select model Dakota.
- * The footstool cannot have any inlays in any other covering or color.
- * Different combination of coverings or different sizes are not previewed in our system. Special requests, if possible, will be considered a "not standard product" and a 10% surcharge will be applied.



MODERN COLLECTION

_Nathalie

End Element
2 Seater

Moving Corner



End Element
Meridienne



Corner Support



_Nathalie K

Classic Corner

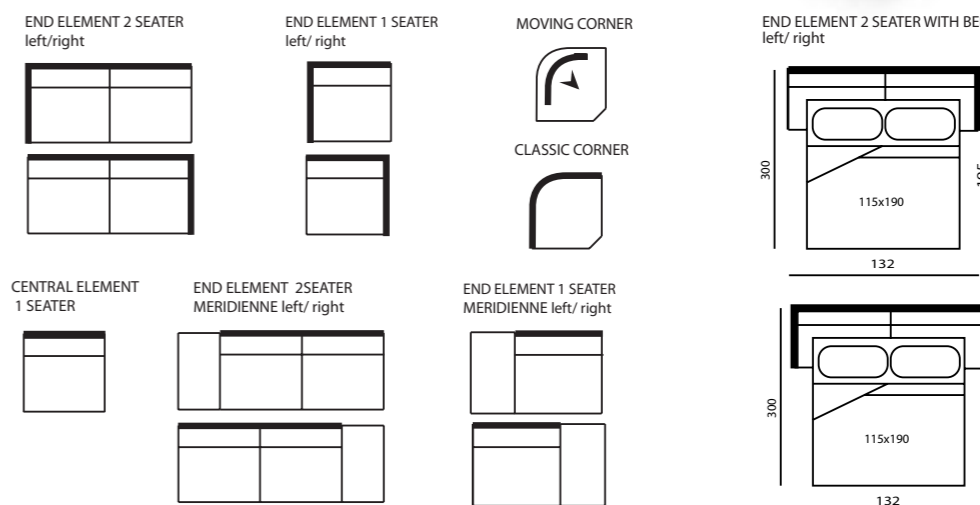

ELEMENTS

	H	L	D	V	W
NATHALIE END ELEMENT 2 SEATER	80/96	165	100	1,35	65
NATHALIE END ELEMENT 1 SEATER	80/96	95	100	0,75	45
NATHALIE END ELEMENT MERIDIENNE 2 SEATER	80/96	190	100	1,55	65
NATHALIE END ELEMENT MERIDIENNE 1 SEATER	80/96	120	100	1,00	45
NATHALIE CENTRAL ELEMENT 1 SEATER	80/96	70	100	0,60	40
NATHALIE MOVING CORNER	70	115	115	1,15	35
NATHALIE CLASSIC CORNER	80	115	115	1,15	40
NATHALIE CORNER CUSHION		75	55	0,1	2
NATHALIE CHAISE LONGUE	80/96	104	170	1,25	53

- * Electrical recliner, additional battery, corner cushions and decor cushions are optional.
- * Position of headrests is manually adjustable in different angles.
- * Electrical recliner can be added only for end elements without meridienne.
- * Bed version with French pull out net can be added only in the end element 2 seater.
- * Corner elements can be movable (Nathalie) or classic (Nathalie K).
- * Different combination of coverings or different sizes are not previewed in our system. Special requests, if possible, will be considered a "not standard product" and a 10% surcharge will be applied.



**MODERN
COLLECTION**

_Park Avenue



2 SEATER SOFA

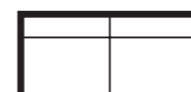

3 SEATER SOFA

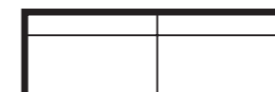

ELEMENTS

	H	L	D	V	W
PARK AVENUE SOFA 3 SEATER	83/99	205	98	1,70	80
PARK AVENUE SOFA 2 SEATER	83/99	177	98	1,45	70

* Position of headrests is manually adjustable in different angles.

* Polished metal legs, not to be chosen.

* Different combination of coverings or different sizes are not previewed in our system. Special requests, if possible, will be considered a "not standard product" and a 10% surcharge will be applied.



MODERN COLLECTION

_Ratina



_Ratina

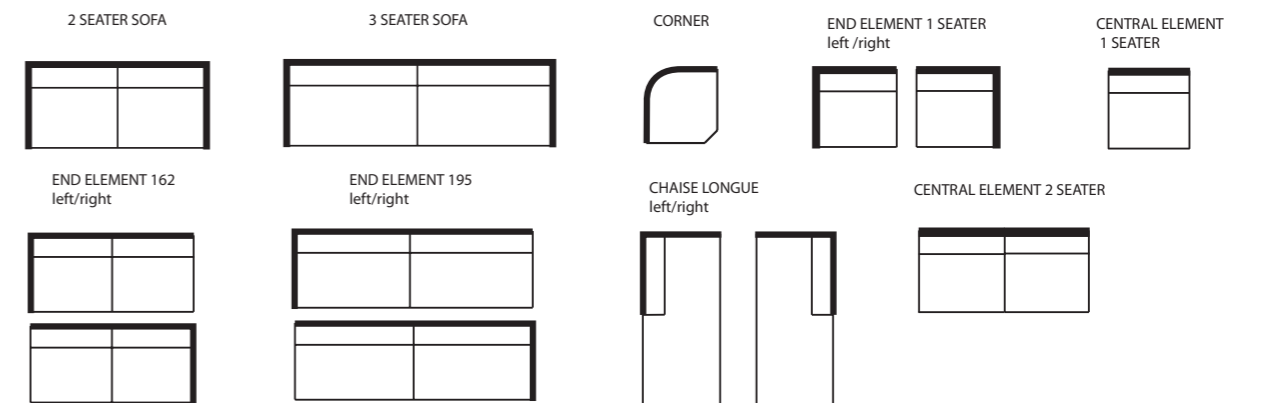

ELEMENTS

	H	L	D	V	W
RATINA SOFA 3 SEATER	96/72	220	110	0,75	70
RATINA SOFA 2 SEATER	96/72	190	110	1,50	60
RATINA END ELEMENT 3 SEATER 195	96/72	195	110	1,50	60
RATINA END ELEMENT 2 SEATER 165	96/72	165	110	1,30	50
RATINA END ELEMENT 1 SEATER	96/72	95	110	0,75	40
RATINA CENTRAL ELEMENT	96/72	70	110	0,55	35
RATINA CENTRAL ELEMENT 2 SEATER	96/72	140	110	1,10	55
RATINA LONGUE CHAIR	96/72	185	110	1,30	65
RATINA CORNER	72	125	125	1,15	35
RATINA STORAGE	55	48	110	0,30	15

END ELEMENT 2 SEATER WITH BED left/ right AND SOFA 2 SEATER

END ELEMENT 3 SEATER WITH BED left/ right AND SOFA 3 SEATER

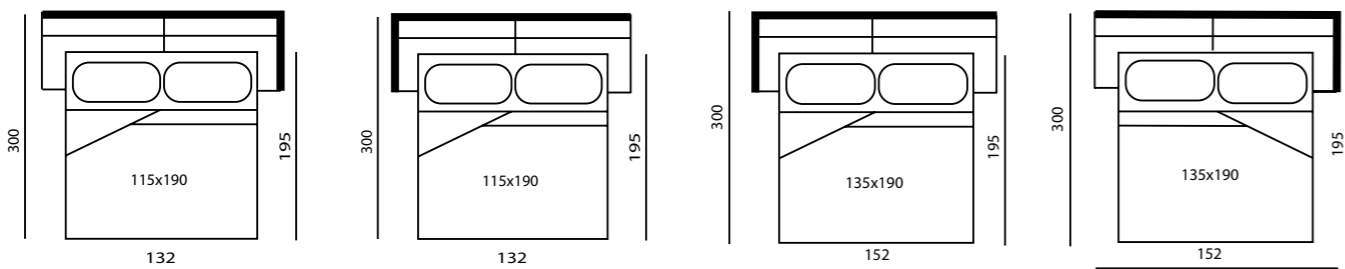

- * Electrical recliner, additional battery and decor cushions are optional.
- * Bed version is possible in all 2 and 3 seater elements.
- * Lumbar cushions are included and stitched to the back seat. Color can be chosen.
- * Contrast stitching are standard, for sur ton stitching is optional.
- * Position of headrests is manually adjustable for higher laying comfort.
- * Different combination of coverings or different sizes are not previewed in our system. Special requests, if possible, will be considered a "not standard product" and a 10% surcharge will be applied.



MODERN COLLECTION



_Sidney



ELEMENTS	H	L	D	V	W
SIDNEY SOFA 2 SEATER	77	138	82	0,90	35
SIDNEY SOFA 3 SEATER	77	185	82	1,15	50
SIDNEY ARMCHAIR	77	85	82	0,55	25
SIDNEY TABLE	33	100	70	0,30	15

- * Stitching tor sur ton standard, not to be chosen.
- * Polished metal legs, not to be chosen.
- * Different combination of coverings or different sizes are not previewed in our system. Special requests, if possible, will be considered a "not standard product" and a 10% surcharge will be applied.



MODERN COLLECTION

_Maldive

_Studio

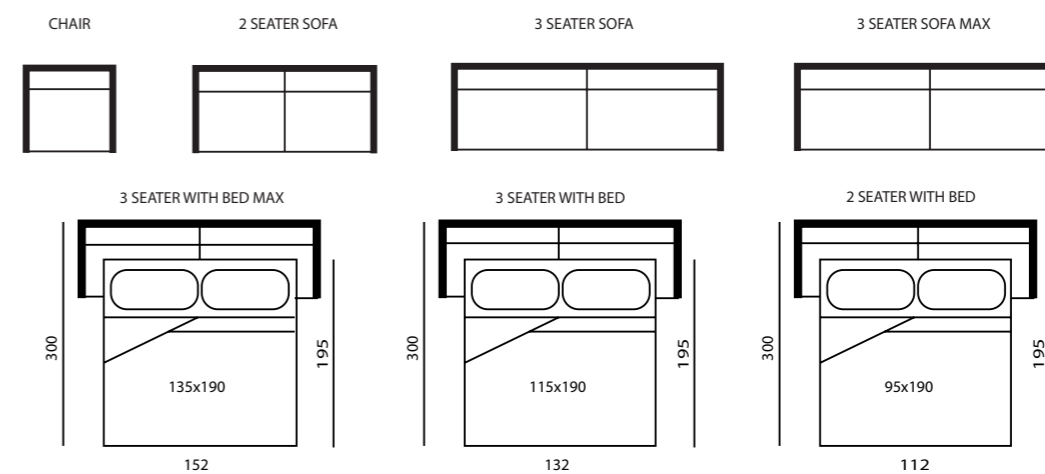

ELEMENTS	H	L	D	V	W
STUDIO SOFA 3 SEATER MAX	75/93	205	100	1,55	80
STUDIO SOFA 3 SEATER	75/93	185	100	1,40	65
STUDIO SOFA 2 SEATER	75/93	165	100	1,30	55
STUDIO ARMCHAIR	75/93	100	100	0,80	40

- * Electrical recliner, additional battery and decor cushions are optional.
- * Bed version is possible in the 2 and 3 seater.
- * Position of headrests is manually adjustable in different angles. Do not pull Headrest when in upright position without pushing it to the end.
- * For different covering combination please select model Maldive.
- * Different combination of coverings or different sizes are not previewed in our system. Special requests, if possible, will be considered a "not standard product" and a 10% surcharge will be applied.



MODERN COLLECTION

_Versus



_Versus



ELEMENTS

	H	L	D	V	W
VERSUS END ELEMENT 2 SEATER	96/78	165	110	1,40	60
VERSUS END ELEMENT 1 SEATER	96/78	95	110	0,80	40
VERSUS END ELEMENT 145	96/78	145	110	1,25	60
VERSUS END ELEMENT 85	96/78	85	110	0,75	35
VERSUS CENTRAL ELEMENT 2 SEATER 140	96/78	140	110	1,10	56
VERSUS CENTRAL ELEMENT 1 SEATER 70	96/78	70	110	0,70	28
VERSUS CENTRAL ELEMENT 2 SEATER 120	96/78	120	110	1,00	50
VERSUS CENTRAL ELEMENT 1 SEATER 60	96/78	60	110	0,60	25
VERSUS CORNER	78	122	122	1,00	48
VERSUS CHAISE LONGUE	96/78	185	110	1,30	65
VERSUS ELEMENT 2 SEATER ADJUSTABLE ARMREST	96/78	195	110	2,00	65
VERSUS ELEMENT 1 SEATER ADJUSTABLE ARMREST	96/78	125	110	1,30	45
VERSUS SOFA 3 SEATER 220	96/78	220	110	2,20	65
VERSUS SOFA 2 SEATER 190	96/78	190	110	2,00	50
VERSUS FOOTSTOOL RECTANGULAR	42	50	110	0,20	10
VERSUS ARMCHAIR	96/78	110	110	0,90	35

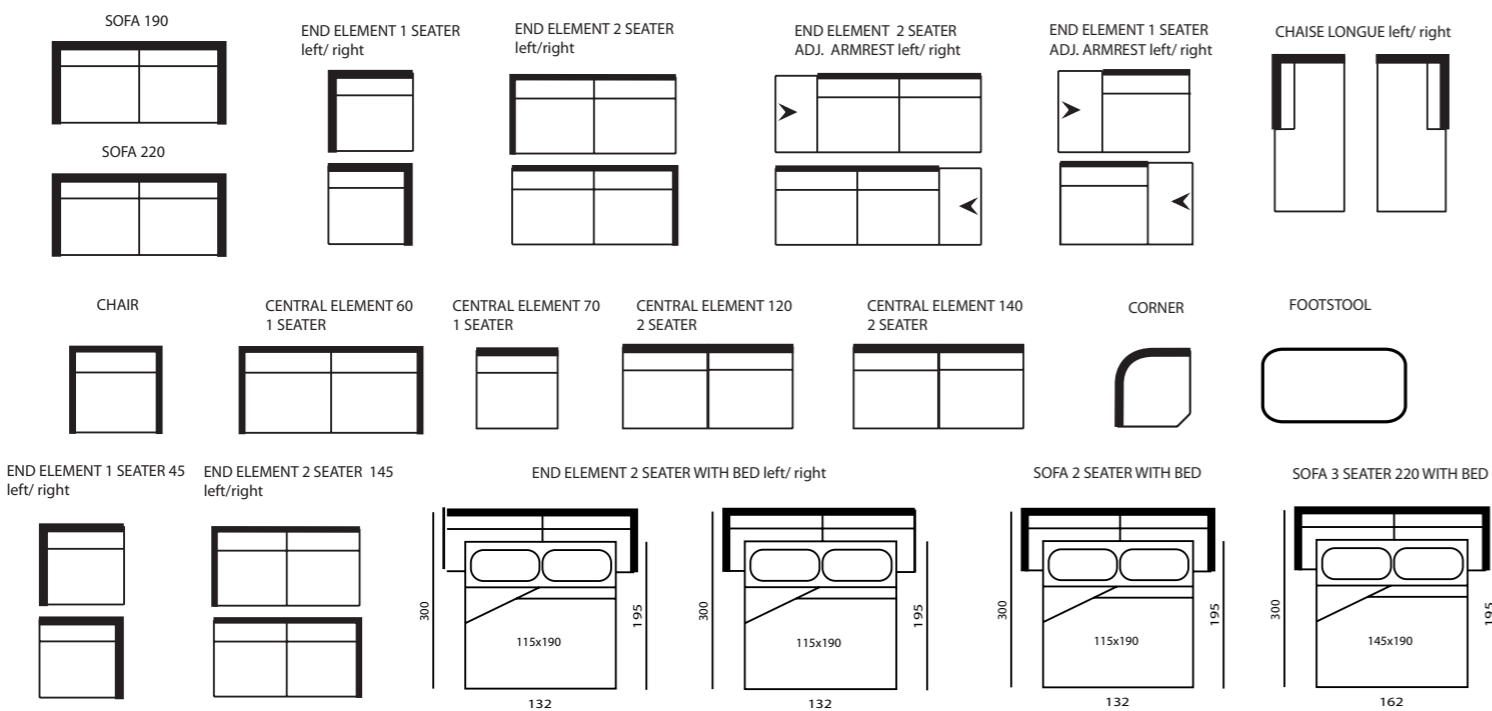

- * Electrical recliner, additional battery and decor cushions are optional.
- * Bed version is possible in all 2 and 3 seater sofas and end elements.
- * Position of headrests is manually adjustable for higher laying comfort.
- * Contrast stitching are standard, for sur ton stitching is optional.
- * Corner element cannot have adjustable headrests.
- * End element with adjustable armrests cannot have the recliner function.
- * Different combination of coverings or different sizes are not previewed in our system. Special requests, if possible, will be considered a "not standard product" and a 10% surcharge will be applied.



MODERN COLLECTION

ELEMENTS

	H	L	D	V	W
WES END ELEMENT 150	78	150	110	1,30	60
WES END ELEMENT 180	78	180	110	1,50	70
WES CHAISE LONGUE	78	130	192	1,95	50
WES FOOTSTOOL	42	126	76	0,60	30

_Wes

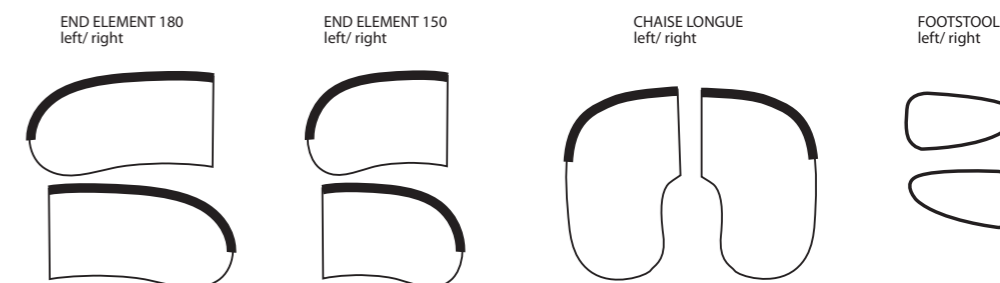

- * For each chaise longue version a corresponding right or left footstool must be matched.
- * Rubber profile painted in metal color.
- * The set includes 5 back cushions 52x62 cm in a chosen covering of our collection.
- * Different combination of coverings or different sizes are not previewed in our system. Special requests, if possible, will be considered a "not standard product" and a 10% surcharge will be applied.

ARM+CHAIRS





ARM+CHAIRS

_Cristina



CHAIR



ELEMENTS

	H	L	D	V	W
CRISTINA ARMCHAIR	82	85	90	0,65	22
CRISTINA ROLL CHAIR	80	85	90	0,65	30

* Different combination of coverings or different sizes are not previewed in our system. Special requests, if possible, will be considered a "not standard product" and a 10% surcharge will be applied.



ARM+CHAIRS

_Easy



CHAIR



ELEMENTS	H	L	D	V	W
EASY ARMCHAIR	90	104	90	0,80	24
EASY ROLL CHAIR	90	104	90	0,80	27

* Different combination of coverings or different sizes are not previewed in our system. Special requests, if possible, will be considered a “not standard product” and a 10% surcharge will be applied.



_Gatsby



CHAIR



ELEMENTS	H	L	D	V	W
GATSBY CHAIR	99	46	67	0,45	15
GATSBY CHAIR WITH ARMRESTS	99	70	67	0,45	15

* The wood color can be chosen among our collection.

* Different combination of coverings or different sizes are not previewed in our system. Special requests, if possible, will be considered a “not standard product” and a 10% surcharge will be applied.



ARM+CHAIRS

_Mida



CHAIR

FOOTSTOOL



ELEMENTS	H	L	D	V	W
MIDA ARMCHAIR	121	77	95	0,88	26
MIDA FOOTSTOOL	45	70	65	0,20	13

* Different combination of coverings or different sizes are not previewed in our system. Special requests, if possible, will be considered a "not standard product" and a 10% surcharge will be applied.



ARM+CHAIRS

_Mimosa



CHAIR



ELEMENTS

	H	L	D	V	W
MIMOSA ARMCHAIR	72	87	83	0,55	24
MIMOSA ROLL CHAIR	72	87	83	0,55	30

* Contrast stitching are standard, tor sur tone stitching can be chosen.
 * Different combination of coverings or different sizes are not previewed in our system. Special requests, if possible, will be considered a "not standard product" and a 10% surcharge will be applied.

_Moira



CHAIR



ELEMENTS

	H	L	D	V	W
MOIRA ARMCHAIR	75	80	83	0,50	26
MOIRA ROLL CHAIR	75	80	83	0,50	32

* Contrast stitching are standard, tor sur tone stitching can be chosen.
 * Different combination of coverings or different sizes are not previewed in our system. Special requests, if possible, will be considered a "not standard product" and a 10% surcharge will be applied.



ARM+CHAIRS

_My Chair



CHAIR FOOTSTOOL



ELEMENTS

	H	L	D	V	W
MY CHAIR CHAIR	101	98	98	0,95	33
MY CHAIR FOOTSTOOL	46	60	58	0,15	11

- * Chesterfield work can be done with leather buttons or swarovski crystals.
- * Legs can be polished in metal color or can be in metal under request.
- * The Side Metal Plate can be left empty or engraved with any name, number or writing under request. If not chosen a serial number will be engraved together with our logo.
- * Different combination of coverings or different sizes are not previewed in our system. Special requests, if possible, will be considered a "not standard product" and a 10% surcharge will be applied.



FOOTSTOOLS

_Ginger k



_Ginger top



_Freddy



_Louis



_M2



_Roger



_Cristina



ELEMENTS	H	L	D	V	W
FREDDY FOOTSTOOL	52	40	40	0,10	13
GINGER K / TOP FOOTSTOOL	52	40	40	0,10	12
ROGER FOOTSTOOL	48	33	33	0,50	3
LOUIS FOOTSTOOL	42	90	60	0,20	13
CRISTINA FOOTSTOOL	38	62	62	0,15	6
M2 FOOTSTOOL	42	70	70	0,30	15

* Ginger top with smoked glass top, available also in polished wood under request.
 * Different combination of coverings or different sizes are not previewed in our system. Special requests will be considered a "non standard product" and a 10% surcharge will be applied.

TABLES





TABLES

_Espace



_Matilde Rectangular



_Matilde Squared



_Tender Side

_Sidney



_Tender Central



ELEMENTS	H	L	D	V	W
ESPACE OVAL TABLE WITH TOP GLASS	37	165	98	0,60	58
SIDNEY TABLE	33	70	100	0,30	15
TENDER SIDE TABLE	43	50	50	0,10	20
TENDER CENTRAL TABLE	32	90	90	0,30	27
MATILDE RECTANGULAR TABLE	30	70	100	0,25	15
MATILDE SQUARED TABLE	30	60	60	0,20	10

* Different combination of coverings or different sizes are not previewed in our system. Special requests will be considered a "non standard product" and a 10% surcharge will be applied.

* Ginger footstool top, also available with wooden base.

GENERAL SALES CONDITIONS AND TECHNICAL SPECIFICATIONS

The pictograms, weights, volumes and dimensions of the products indicated in the catalogue are purely indicative. The colours and sizes listed may not faithfully reproduce the real ones and cannot be the subject of any complaint.

An extra charge of 10% may be applied for not standard production.

Excluding exceptionally busy periods or holidays breaks the average delivery term for our STANDARD products varies from eight to ten weeks. For NON STANDARD products or special production the delivery time may be increased of 2-4 weeks. The exact time will be stated in our written confirmation. Please always carefully check it and timely report unclear issues.

Roma Imperiale has the right to make changes without notice. The information contained in this publication are not binding. Some product might go out of production from one publication to the other so please always ask for products' availability.



PRODUCT INFORMATION

- The structure is made of solid poplar or beech wood.
- The product is assembled using glue and interlocking joints.
- All our materials comply with European standards.
- The seat support is sustained by elastic belts.
- The filling and Dacron are CFC-free.
- The leather upholstery is PCP-free.
- The packaging is recyclable.
- The bed function changes the design of the sofa. Bed nets can be 2 folds or 3 folds according to the chosen model.
- The electrical recliners works with a 220 voltage. For lower voltages please ask for the special adaptor.
- Mechanical headrests can be put in any of its inclined position by gently lifting up the cushions with both hands, and can be closed back by pushing the mechanism till the end until it softens and then put it back in the original position.
- Do not move the sofa by pulling it or pushing it from the headrests or armrests with mechanism as they can be damaged.

LIGHT PADDING FURNITURE PRODUCTS

Upholstered furniture with international flair and style mainly has "light padding". It expresses casual elegance and comfortable, cosy seating. When new this upholstery appears relatively smooth, in use it becomes soft and snug and most enjoyable. Most of the Neri upholstered furniture are manufactured according to modern criteria with "light padding". If you have chosen cushions of a down feather-type or with a Dacron soft inlay we would like to remind you that the content of the cushions is distributed equally into individual chambers. The formation of waves and hollows in usage is not a sign of low quality but of its natural and genuine materials and expert crafting.

According to the intensity of use especially in the area of the "favourite seating place", regular shaking or plumping may be necessary. Claims for such a natural feature such as "light padding" will not be accepted.

WARNING! ACHTUNG! ATTENTION!

JOINTS FOR CORNER ELEMENT ARE INSIDE THE PACKAGING OR THE SOFA OR ARE ATTACHED TO THE SIDE. IN ORDER TO JOIN ELEMENTS JUST LIFT UP THE ELEMENT WITH THE MALE JOINTS AND INSERT THEM INTO THE FEMALE JOINTS.



MAINTANANCE INSTRUCTIONS FOR CLEANING AND CARE

Leather furniture might be compared with the car of your body. How you use and take care of your upholstered furniture is therefore essential for its appearance and life expectancy. Experience shows that the lighter and more natural the type of cover material the more sensitive it is to outer influences.

Please observe at all time the following care instructions:

- Never treat leather with solvents of any kind (e.g. turpentine, stain remover, cleaning paraffin, shoe polish, floor polish or any type of detergent). Please follow our recommended instructions as otherwise any claims under guarantee may become invalid.
- Any kind of stain must be removed immediately and in the proper way. Pay attention not to use in an improper way any cloths, detergents, chemical or mechanical products that could cause irreparable damages. It's important to distinguish the type of stain:
 - OILY stains (e.g. oil, chocolate, mayonnaise): use blotting-paper to absorb and remove the oil substance from the surface. Clean with a damp cloth, not abrasive, soaked in water and neutral soap and then dry gently with another clean cloth.
 - SOLUBLE stain (e.g. Coffee, tea, milk): use a clean cloth, not abrasive, soaked in water and neutral soap. Remove the soluble substance and dry with another clean cloth.
 - DRY stains: first of all don't rub the dirty part. Take a soft brush and brush very gently.



For any other specific questions in the field of leather cleaning and leather care please contact directly our partner:

UNITERS S.p.A. _ Leather Masters

Via E. De Nicola, 1 36075 Montecchio Maggiore (VI) Italy

Phone number: +39 444 499099 Fax Number: +39 444 499106

Informazioni generali: info@uniters.com

LCK Leather Care Keller GmbH

Im Unterfeld 2, D-76698 Ubstadt-Weiher, Germany

Phone: (49) 7251 9625 0 • Fax: (49) 7251 9625 29 • E-mail: info@lck-international.com - www.lederpflege.de

NOVABUK FURNITURE AND FABRIC FURNITURE

Novabuk is a special new material made in part of leather and in part of microfiber, which gives it more resistance, is water and fire repellent and it's very easy to clean but it still keeps the soft touch of Nabuk.

Novabuk furniture can be cleaned with simple water by just rubbing the stained part gently with a smooth cloth, or by using special products suited for fabrics containing non aggressive agents.

Do not use alcohol or any other solvent for either Novabuk or other fabrics of our collection.

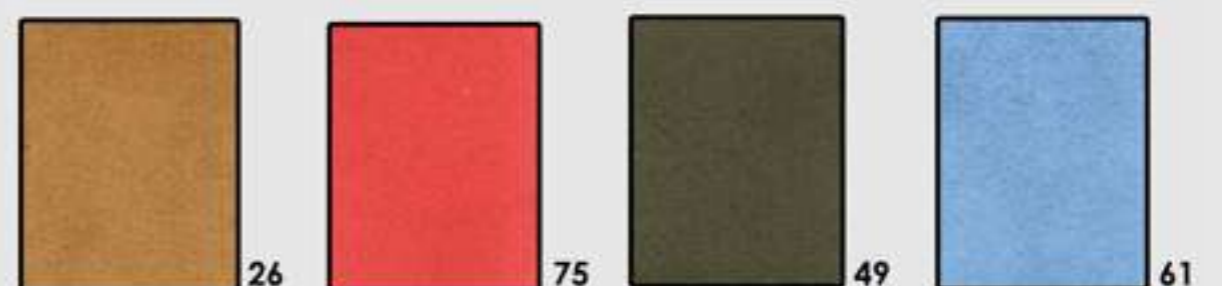
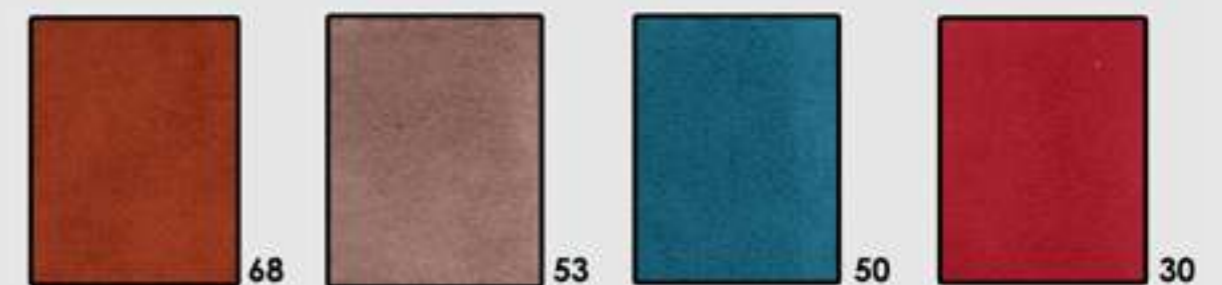
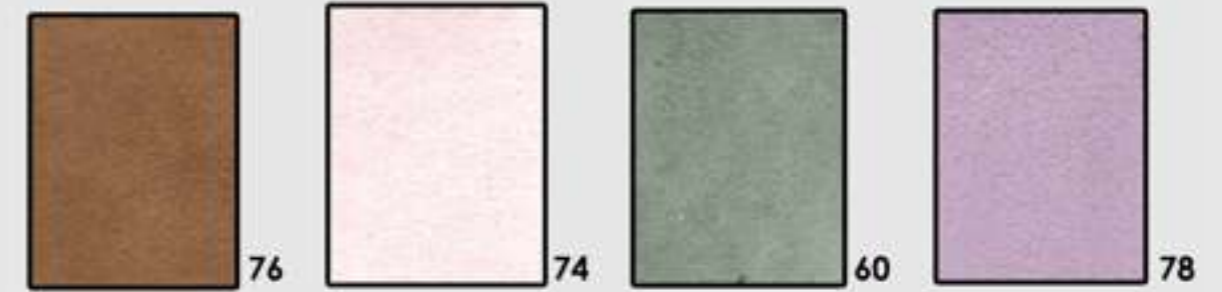
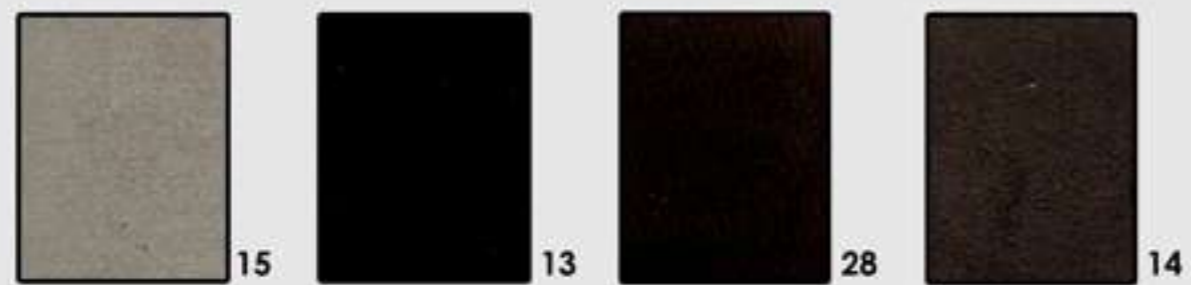
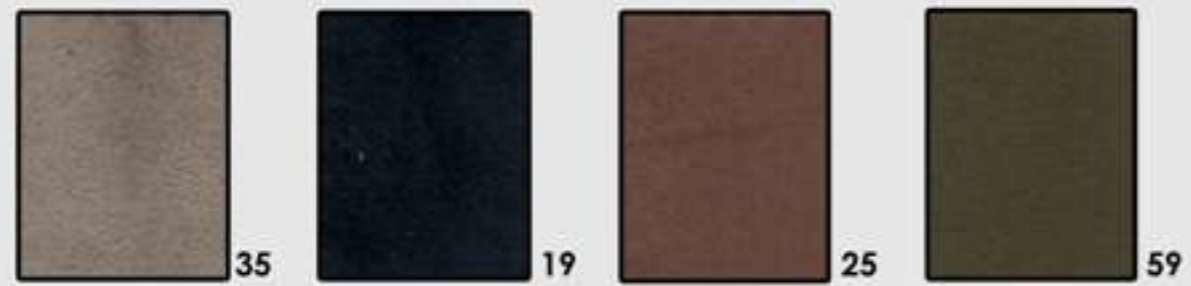



9200



9100



9004



9400



1003



1007



9248



1001



1016



9628



9629



9604



1008



9646



9998



9206



9623



9999

MUN CERTIFICATION OF 100% MADE IN ITALY _ NATIONAL MANUFACTURING

Our Company and brand Nieri exists in the Tuscan Territory, and more precisely in Quarrata since 1929.

We are proud to be one of the few Furniture companies to have our operating seat in the same Italian town when it all started, and to keep doing our job with the same values, the same craftsmanship, the same art and love of the same people who were here since the beginning.

This is a Family business, we believe in our country and in our territory, and we want to keep our quality, our standards and our products at a high level without having to displace our production or give up our traditions and quality standards.

That is why we decided to certificate our factory and brand with the MUN_Marchio Unico Nazionale, The National Manufacturing Certificate granted from Lloyd Register, an international Authority which, thanks to its procedures, can guarantee that all processes of our production, our materials, our manpower are actually 100% Made in Italy (actually Made in Tuscany in our case).

For more information please check the web site www.marchiouniconazionale.it

CERTIFICATE OF AUTHENTICITY

Roma Imperiale srl warrants that the products in this catalogues are authentic Nieri products. Nieri relies on first-rate, exclusive materials as well as on specialists' several years' expertise, so that the product can look like a one-of-a-kind object.

100% MADE IN ITALY

A unique blend of tradition and technology is what sets Nieri apart in terms of production. Nieri's products are craft-finished, while making the most of everything that is offered by industry, with a view to achieving the highest tailoring standard, strictly and genuinely Italian made. This is made possible by the company's long craft history, through highly professional dealers' proven skills and expertise as matched with the state-of-the-art working machines, which result in high-precision, mechanised cutting, whereas trained artisans are the name for remarkable sensitivity and unparalleled expertise in refining details, approaching sofas as finely tailored products. Expert hands producing quality, hands guided by passion and creativity, skilled, conscientious hands. Hands respectful of tradition and capable of controlling technology. Hands proud of developing ITALIAN MADE products.

TEXTILE AND LEATHER COLLECTION

The textile collection is one of Nieri's main pluses, much emphasis being placed on it and major resources being devoted to it. A new fabric and leather collection is developed every year, based on sophisticated textures and first-rate yarns, charming glossy/matt effects and structured wefts, specially designed by the company and exclusively manufactured for Nieri, to cater to the personal taste of anyone who is not fond of the idea of mass production. A unique collection which magnifies the high quality standard and creates a competitive edge for the seating systems. From cotton to velvet, from linen to chenille, from Nubuk to leather: Nieri's covers are the ultimate synthesis of comfort and versatility, lightness and durability, luxury and fashion. Many types of fabric capable of enhancing fine details and resulting in different characters and personalities for the products, according to one's own taste and lifestyle. Nieri's leather emphasizes the outstanding quality of both the products and the tailoring details, thus providing a unique plus. Leather means tradition, emotion and dexterity: investing in surveys and research has allowed Nieri to make customized colours, finishes and tanning available, with a view to developing products catering to the most sophisticated needs. The quality of Nieri's fabrics and leather is guaranteed by several strict, purpose-designed tests, in accordance with the most stringent European standards



CERTIFICATE OF WARRANTY

Regardless of, and in addition to, law provisions concerning product warranties, Roma Imperiale srl warrants the frames of its upholstered products (sofas, armchairs, chairs and sofas) for 10 years (from date of invoice). The leather and fabric covers, upholstery, mechanisms, accessories and component parts are covered by 24 months warranty. The warranty period for the occasional tables, is 2 years. The warranty covers original manufacturing defects of the product and includes free replacement or repair of such damaged or defective parts as acknowledged by Nieri or any representative designated by Nieri.

The warranty does not cover any damage caused by normal wear, mistreatment or misuse, accidental breakage or acts of God, nor does the warranty cover any defects other than those attributable to Roma Imperiale srl, including improper assembly or any assembly that does not comply with the mounting instructions. The warranty will not be applicable if the products are dismantled, modified or repaired by any third parties that are not authorized by Roma Imperiale srl. The warranty does not include fabrics and leather supplied by the Customer.

Leather is a natural product which keeps a few properties – even when worked – which define its origin, without affecting durability and quality: insect bites, small healed wounds, marks, wrinkles, differences in “grain” should be considered to be characteristics, and not defects. The natural adjustment of the upholstery is not a defect either. Wood is a “live” material: any small movements as temperature and humidity change are absolutely natural, and should be considered to be typical of furniture. Any warranty jobs will not cause the warranty to cease to be applicable. The warranty will cease to be valid after 10 years of the date of invoice. To exercise the rights arising from the warranty, this “Certificate of Warranty” and the purchase invoice shall be shown to Roma Imperiale srl and be kept throughout the period of validity of the warranty.



PACKAGING

Our packaging is designed to face each and every kind of shipping, weather conditions and kind of transport. As we do know that our products are delicate and valuable, that leather and wood are sensible to changes of temperature and to continuous pulling forces we provide a multilevel packaging.

1. The first layer is either cardboard or foam for the most sensitive part of the sofa and according to the model.
2. Secondly the whole sofa or piece of sofa is enveloped in a layer of nylon as to protect it from dust.
3. The third layer is a special plastic material called FOAMM which is flexible but more resistant than simple plastic layers, which is to protect the sofas from scratches or internal damages if the sofa is shacked or pulled along a wall.
4. Finally an airball envelop with our logos and our labels is wrapped around the whole pack and tied with strings and adhesive tape.

In this way we ship all over the world by ship, airplane, trucks and all our products come undamaged to their final destination for happy customers.

You can see a part of the production system and packaging at: <http://www.romaimperiale.net/made-in-Italy>

DIVANO CON MECCANISMO
CARICARE IN POSIZIONE ORIZZONTALE SUI PROPRI PIEDI,
NON IN VERTICALE SUI BRACCIOLLI.

DO NOT LOAD UPSIDE-DOWN OR ON THE SIDES
NE PAS CHARGER SUR LE DOSSIER NI SUR LES ACCOUDEURS
WAAR DARF NIJER WAAGRECHT VERLADEN WORDEN

ATTENZIONE – FRAGILE!!!!
CONTIENE ACCESSORI E MECCANISMI DELICATI
NON SOVRACCARICARE

ATTENTION – FRAGILE !!!
IL CONTIENT ACCESSOIRES ET MECCANISMES DELICATS
NE PAS SURCHARGER

VORSICHT – ZERBRECHLICH !!!!
Enthält mechanische teile
VOR NÄSSE UND DRUCK SCHÜTZEN



CONTACTS

*Tradition is Handmade,
Handmade means Nieri.*



fatto a mano

Roma Imperiale Srl

Head Office

Address: Piazza del Popolo, 18 00187 Roma (RM) Italy

Phone: +39 0573 7733 Fax: +39 0573 739710

E-mail: info@romaimperiale.net





Operating Office

Address: Via Bologna, 13 51039 Quarrata (PT) Italy

Phone: +39 0573 7733 Fax: +39 0573 739710

E-mail: info@romaimperiale.net

For any question, quotation or information about our products and company you can contact the following references:

 Information in English	info.en@romaimperiale.net
 Informationen auf Deutsch	info.de@romaimperiale.net
 Renseignements en Français	info.fr@romaimperiale.net
 Información en Español	info.es@romaimperiale.net
 информация на русском языке	info.ru@romaimperiale.net

For more information please check also our web sites:

www.romaimperiale.net - www.nieri.it - www.niericountry.it
www.nierifrance.com - www.nieridivani.it

CREDITS :

PH: Ambra Vaglini

GRAPHIC DESIGN: Ambra Vaglini

PRINTING: Toccafondi 1910

Luglio 2016

NIERI is a trademark of ROMA IMPERIALE srl

Via Bologna, 13 - 51039 - Quarrata - PT- ITALY
tel: 0039 0573 7733 - fax: 0039 0573 739710



CERTIFIED COMPANY MUN
NATIONAL MANUFACTURING
ITCOT.MUN-A000016